

HIKVISION



PanoVu Series Network Camera

User Manual

User Manual

COPYRIGHT ©2017 Hangzhou Hikvision Digital Technology Co., Ltd.

ALL RIGHTS RESERVED.

Any and all information, including, among others, wordings, pictures, graphs are the properties of Hangzhou Hikvision Digital Technology Co., Ltd. or its subsidiaries (hereinafter referred to be "Hikvision"). This user manual (hereinafter referred to be "the Manual") cannot be reproduced, changed, translated, or distributed, partially or wholly, by any means, without the prior written permission of Hikvision. Unless otherwise stipulated, Hikvision does not make any warranties, guarantees or representations, express or implied, regarding to the Manual.

About this Manual

This Manual is applicable to PanoVu Series Network Camera.

The Manual includes instructions for using and managing the product. Pictures, charts, images and all other information hereinafter are for description and explanation only. The information contained in the Manual is subject to change, without notice, due to firmware updates or other reasons. Please find the latest version in the company website (<http://overseas.hikvision.com/en/>). Please use this user manual under the guidance of professionals.

Trademarks Acknowledgement

HIKVISION and other Hikvision's trademarks and logos are the properties of Hikvision in various jurisdictions. Other trademarks and logos mentioned below are the properties of their respective owners.

Legal Disclaimer

TO THE MAXIMUM EXTENT PERMITTED BY APPLICABLE LAW, THE PRODUCT DESCRIBED, WITH ITS HARDWARE, SOFTWARE AND FIRMWARE, IS PROVIDED "AS IS", WITH ALL FAULTS AND ERRORS, AND HIKVISION MAKES NO WARRANTIES, EXPRESS OR IMPLIED, INCLUDING WITHOUT LIMITATION, MERCHANTABILITY, SATISFACTORY QUALITY, FITNESS FOR A PARTICULAR PURPOSE, AND NON-INFRINGEMENT OF THIRD PARTY. IN NO EVENT WILL HIKVISION, ITS DIRECTORS, OFFICERS, EMPLOYEES, OR AGENTS BE LIABLE TO YOU FOR ANY SPECIAL, CONSEQUENTIAL, INCIDENTAL, OR INDIRECT DAMAGES, INCLUDING, AMONG OTHERS, DAMAGES FOR LOSS OF BUSINESS PROFITS, BUSINESS INTERRUPTION, OR LOSS OF DATA OR DOCUMENTATION, IN CONNECTION WITH THE

USE OF THIS PRODUCT, EVEN IF HIKVISION HAS BEEN ADVISED OF THE POSSIBILITY OF SUCH DAMAGES. REGARDING TO THE PRODUCT WITH INTERNET ACCESS, THE USE OF PRODUCT SHALL BE WHOLLY AT YOUR OWN RISKS. HIKVISION SHALL NOT TAKE ANY RESPONSIBILITIES FOR ABNORMAL OPERATION, PRIVACY LEAKAGE OR OTHER DAMAGES RESULTING FROM CYBER ATTACK, HACKER ATTACK, VIRUS INSPECTION, OR OTHER INTERNET SECURITY RISKS; HOWEVER, HIKVISION WILL PROVIDE TIMELY TECHNICAL SUPPORT IF REQUIRED. SURVEILLANCE LAWS VARY BY JURISDICTION. PLEASE CHECK ALL RELEVANT LAWS IN YOUR JURISDICTION BEFORE USING THIS PRODUCT IN ORDER TO ENSURE THAT YOUR USE CONFORMS THE APPLICABLE LAW. HIKVISION SHALL NOT BE LIABLE IN THE EVENT THAT THIS PRODUCT IS USED WITH ILLEGITIMATE PURPOSES. IN THE EVENT OF ANY CONFLICTS BETWEEN THIS MANUAL AND THE APPLICABLE LAW, THE LATER PREVAILS.

Regulatory Information

FCC Information

Please take attention that changes or modification not expressly approved by the party responsible for compliance could void the user's authority to operate the equipment.

FCC compliance: This equipment has been tested and found to comply with the limits for a Class A digital device, pursuant to part 15 of the FCC Rules. These limits are designed to provide reasonable protection against harmful interference when the equipment is operated in a commercial environment. This equipment generates, uses, and can radiate radio frequency energy and, if not installed and used in accordance with the instruction manual, may cause harmful interference to radio communications. Operation of this equipment in a residential area is likely to cause harmful interference in which case the user will be required to correct the interference at his own expense.

FCC Conditions

This device complies with part 15 of the FCC Rules. Operation is subject to the following two conditions:

1. This device may not cause harmful interference.
2. This device must accept any interference received, including interference that may cause undesired operation.

EU Conformity Statement



This product and - if applicable - the supplied accessories too are marked with "CE" and comply therefore with the applicable

harmonized European standards listed under the EMC Directive 2014/30/EU, the RoHS Directive 2011/65/EU



2012/19/EU (WEEE directive): Products marked with this symbol cannot be disposed of as unsorted municipal waste in the European Union. For proper recycling, return this product to your local supplier upon the purchase of

equivalent new equipment, or dispose of it at designated collection points. For more information see: www.recyclethis.info.



2006/66/EC (battery directive): This product contains a battery that cannot be disposed of as unsorted municipal waste in the European Union. See the product documentation for specific

battery information. The battery is marked with this symbol, which may include lettering to indicate cadmium (Cd), lead (Pb), or mercury (Hg). For proper recycling, return the battery to your supplier or to a designated collection point. For more information see: www.recyclethis.info.

Industry Canada ICES-003 Compliance

This device meets the CAN ICES-3 (A)/NMB-3(A) standards requirements.

Safety Instruction

These instructions are intended to ensure that the user can use the product correctly to avoid danger or property loss.

The precaution measure is divided into 'Warnings' and 'Cautions':

Warnings: Serious injury or death may be caused if any of these warnings are neglected.

Cautions: Injury or equipment damage may be caused if any of these cautions are neglected.



Warnings:

- Please adopt the power adapter which can meet the safety extra low voltage (SELV) standard. The power consumption cannot be less than the required value.
- Do not connect several devices to one power adapter as an adapter overload may cause over-heating and can be a fire hazard.
- When the product is installed on a wall or ceiling, the device should be firmly fixed.
- To reduce the risk of fire or electrical shock, do not expose the indoor used product to rain or moisture.
- This installation should be made by a qualified service person and should conform to all the local codes.
- Please install blackouts equipment into the power supply circuit for convenient supply interruption.
- If the product does not work properly, please contact your dealer or the nearest service center. Never attempt to disassemble the product yourself. (We shall not assume any responsibility for problems caused by unauthorized repair or maintenance.)
- Please do not look directly into the laser light within 6 meters because laser is hazardous to humans.



Cautions:

- Make sure the power supply voltage is correct before using the product.
- Do not drop the product or subject it to physical shock. Do not install the product on vibratory surface or places.
- Do not expose it to high electromagnetic radiating environment.
- Do not aim the lens at the strong light such as sun or incandescent lamp. The strong light can cause fatal damage to the product.
- The sensor may be burned out by a laser beam, so when any laser equipment is being used, make sure that the surface of the sensor not be exposed to the laser beam.
- For working temperature, please refer to the specification manual for details.
- To avoid heat accumulation, good ventilation is required for a proper operating environment.
- While shipping, the product should be packed in its original packing.

Warnings Follow these safeguards to prevent serious injury or death.	Cautions Follow these precautions to prevent potential injury or material damage.

- Please use the provided glove when open up the product cover. Do not touch the product cover with fingers directly, because the acidic sweat of the fingers may erode the surface coating of the product cover.
- Please use a soft and dry cloth when clean inside and outside surfaces of the product cover. Do not use alkaline detergents.
- Improper use or replacement of the battery may result in hazard of explosion. Please use the manufacturer recommended battery type.

Table of Contents

ABOUT THIS DOCUMENT	1
OVERVIEW OF CONTENTS	1
NOTICE	1
CHAPTER 1 ACTIVATING AND ACCESSING TO THE CAMERA	2
1.1 SYSTEM REQUIREMENT	2
1.2 ACTIVATING THE CAMERA.....	2
1.2.1 <i>Setting the Camera over the LAN</i>	2
1.2.2 <i>Activating the Camera</i>	3
1.3 SETTING THE CAMERA OVER THE WAN (OPTIONAL).....	7
1.3.1 <i>Static IP Connection</i>	7
1.3.2 <i>Dynamic IP Connection</i>	8
1.4 ACCESSING TO THE CAMERA	9
1.4.1 <i>Accessing by Web Browsers</i>	9
1.4.2 <i>Accessing by Client Software</i>	10
1.5 POWER-UP ACTION.....	11
CHAPTER 2 SETTING LOCAL PARAMETERS AND NETWORK.....	12
2.1 CONFIGURING LOCAL PARAMETERS	12
2.2 CONFIGURING NETWORK SETTINGS.....	13
2.2.1 <i>Basic Settings</i>	13
2.2.2 <i>Advanced Settings</i>	17
CHAPTER 3 LIVE VIEW	25
3.1 INSTALL THE PLUG-IN.....	25
3.2 LIVE VIEW PAGE	25
3.2.1 <i>Descriptions of the live view page:</i>	25
3.2.2 <i>Live View Operation</i>	26
3.3 CONFIGURING IMAGE SETTINGS.....	30
3.3.1 <i>Configuring Display Settings</i>	30
3.3.2 <i>Configuring OSD Settings</i>	35
3.3.3 <i>Configuring Text Overlay Settings</i>	37
3.4 CONFIGURING VIDEO AND AUDIO SETTINGS.....	37
3.4.1 <i>Configuring Video Settings</i>	37
3.4.2 <i>Configuring Audio Settings</i>	39
3.4.3 <i>Configuring ROI Settings</i>	39
CHAPTER 4 PTZ CONTROL.....	41
4.1 OPERATING PTZ CONTROL	41
4.1.1 <i>Setting/Calling a Preset</i>	41
4.1.2 <i>Setting/Calling a Patrol</i>	43
4.1.3 <i>Setting/Calling a Pattern</i>	44
4.2 PTZ CONFIGURATION	45
4.2.1 <i>Configuring Basic PTZ Parameters</i>	45
4.2.2 <i>Configuring PTZ Limits</i>	46

4.2.3	Configuring Initial Position	47
4.2.4	Configuring Park Action.....	48
4.2.5	Configuring Privacy Mask.....	49
4.2.6	Configuring Scheduled Tasks.....	50
4.2.7	Clearing PTZ Configurations	52
4.2.8	Configuring PTZ Control Priority.....	52
4.2.9	Configuring Panorama Tracking	53
4.2.10	Configuring Eagle Vision Focus.....	54
CHAPTER 5	STORAGE AND PLAYBACK	56
5.1	STORAGE SETTINGS	56
5.1.1	Configuring Net HDD (Optional).....	56
5.1.2	HDD Management.....	57
5.1.3	Configuring Record Schedule	58
5.1.4	Configuring Capture Schedule	60
5.2	PICTURE.....	61
5.3	PLAYBACK	62
5.3.1	Play Back Video Files	62
5.3.2	Downloading Video Files.....	64
CHAPTER 6	ALARM AND EVENTS	66
6.1	BASIC EVENT CONFIGURATION	66
6.1.1	Configuring Motion Detection	66
6.1.2	Configuring Video Tampering Alarm	70
6.1.3	Configuring Video Loss Alarm	71
6.1.4	Configuring Alarm Input	72
6.1.5	Configuring Alarm Output	73
6.1.6	Handling Exception.....	74
6.2	SMART EVENT CONFIGURATION.....	74
6.2.1	Detecting Audio Exception.....	74
6.3	VCA CONFIGURATION	76
6.3.1	VCA Configuration description.....	76
6.3.2	Configuring VCA Information (Overlay & Capture).....	78
6.3.3	Zooming Ratio	79
6.3.4	Advanced Configuration	80
6.3.5	Scene Configuration.....	82
6.3.6	Scene Auto-switch.....	85
6.3.7	Face Capture.....	86
6.3.8	Shield Region	86
6.3.9	Rule Configuration Demonstration	88
CHAPTER 7	MAINTENANCE.....	93
7.1	SYSTEM SETTING	93
7.1.1	Viewing Basic Information.....	93
7.1.2	Time Settings.....	93
7.1.3	Configuring RS-485.....	95
7.1.4	Configuring DST (Daylight Saving Time).....	96
7.2	MAINTENANCE.....	96

7.2.1	<i>Upgrade & Maintenance</i>	96
7.2.2	<i>Log Searching</i>	98
7.2.3	<i>System Service</i>	99
7.3	SECURITY	99
7.3.1	<i>Configuring Authentication</i>	99
7.3.2	<i>Configuring IP Address Filter</i>	99
7.3.3	<i>Configuring Security Service Settings</i>	101
7.4	USER MANAGEMENT	101
APPENDIX	104
APPENDIX 1	SADP SOFTWARE INTRODUCTION	104
APPENDIX 2	STATICS, INTERFERENCE LIGHTNING AND SURGE PROTECTION	106
APPENDIX 3	WATERPROOF.....	109
APPENDIX 4	BUBBLE MAINTENANCE.....	110
APPENDIX 5	RS-485 BUS CONNECTION	111
APPENDIX 6	24VAC WIRE GAUGE & TRANSMISSION DISTANCE.....	113
APPENDIX 7	12VDC WIRE GAUGE & TRANSMISSION DISTANCE	114
APPENDIX 8	TABLE OF WIRE GAUGE STANDARDS.....	115
APPENDIX 9	ALARM IN/OUT CONNECTIONS.....	116
APPENDIX 10	CAMERA FUNCTION DESCRIPTION	117

About This Document

This document introduces PanoVu series network camera, including 360° panoramic + PTZ camera, 180° panoramic + PTZ camera, and 360° panoramic camera. It covers how to activate and access to the camera, and operate the camera in the network environment.

Overview of Contents

This document contains the following chapters, sections and appendixes:

Chapter1 Activating and Accessing to the Camera provides procedures for setting network environment, activating and accessing the camera by web browsers and client software, and introduces the power-up action.

Chapter2 Setting Local Parameters and Network suggests the basic settings, including viewing device local information, configuring saving paths of files, network settings, and other settings.

Chapter3 Live View describes how to view video and configure the available settings for the camera via web browser.

Chapter4 PTZ Control describes the PTZ function of camera, including preset, patrol, and pattern. It also suggests the PTZ configurations, such as PTZ limits, initial position, and park actions, etc..

Chapter5 Storage and Playback introduces how to set the storage, set the recording schedule and capture schedule to trigger the recording and capture by events, and how to view the pictures and play back the saved video files.

Chapter6 Alarm and Events explains how to configure the camera to respond to alarm events, and make the events to trigger alarm actions.

Chapter7 Maintenance describes how to set the system settings, security settings and user management, including time settings, RS-485 settings, and DST settings, etc.

Appendix describes the SADP software, surge protection and details, attention of waterproof measurements and bubble maintenance, RS-485 bus connection details, wire gauge standards and transmission distance, and alarm in/out connections, etc.

Notice

The Camera 1 is the PTZ channel, and the Camera 2 and Camera 3 are the panoramic view channels. All PTZ functions, including privacy mask, and ROI function are only supported by Camera 1.

Chapter 1 Activating and Accessing to the Camera

1.1 System Requirement

System requirements of web browser accessing are as follows:

Operating System: Microsoft Windows XP SP1 and above version/Vista/Win7/Server 2003/Server 2008 32bits

CPU: Intel Pentium IV 3.0 GHz or higher

RAM: 1G or higher

Display: 1024 × 768 resolution or higher

Web Browser: Internet Explorer 8.0 and above version, Apple Safari 5.02 and above version, Mozilla Firefox 5 and above version and Google Chrome 18 and above versions.

1.2 Activating the Camera

1.2.1 Setting the Camera over the LAN

Purpose:

To view and configure the camera via the LAN, you need to connect the camera in the same subnet with your computer, and install the SADP or client software to search and change the IP address of the camera.

Note:

For the detailed introduction of SADP, refer to Appendix 1.

The following figures show the two ways of cable connection of a camera and a computer:

Purpose:

- To test the camera, you can directly connect the camera to the computer with a network cable as shown in Figure 1-1.
- Refer to Figure 1-2 to set the camera over the LAN via a switch or a router.

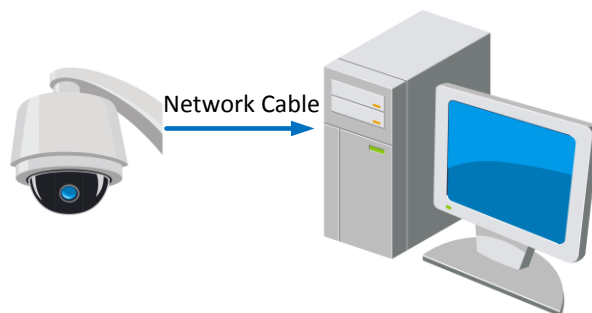

Figure 1-1 Connecting Directly

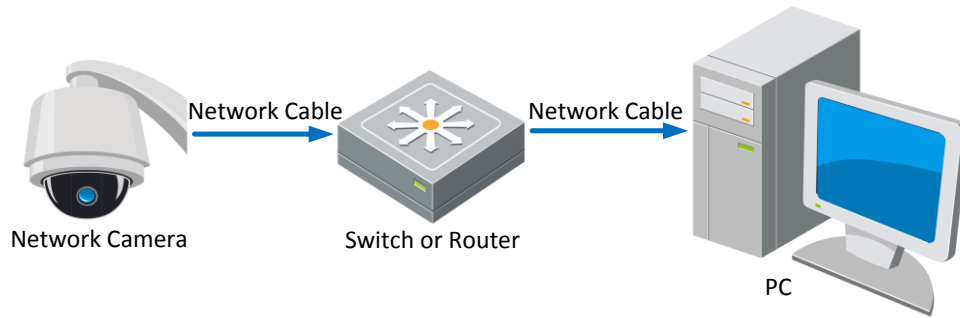

Figure 1-2 Connecting via an Switch or a Router

1.2.2 Activating the Camera

Purpose:

You are required to activate the camera first before you can use the camera.

Activation via web browser, activation via SADP, and activation via client software are supported. In the following sections, activation via web browser and activation via SADP will be taken as examples. You may refer to the user manual of the camera for details of activation via client software.

◆ **Activation via Web Browser**

Steps:

1. Power on the camera, and connect the camera to the network.
2. Input the IP address into the address bar of the web browser, and click **Enter** to enter the activation interface.

Note:

The default IP address of the camera is 192.168.1.64.

Activation

User Name	admin
Password	<input type="password"/>
Valid password range [8-16]. You can use a combination of numbers, lowercase, uppercase and special character for your password with at least two kinds of them contained.	
Confirm	<input type="password"/>

OK

Figure 1-3 Activation Interface (Web Browser)

3. Create a password and input the password into the password field.



STRONG PASSWORD RECOMMENDED— We highly recommend you create a strong password of your own choosing (Using a minimum of 8 characters, including at least three of the following categories: upper case letters, lower case letters, numbers, and special characters.) in order to increase the security of your product. And we recommend you reset your password regularly, especially in the high security system, resetting the password monthly or weekly can better protect your product.

4. Confirm the password.
5. Click **OK** to activate the camera and enter the live view interface.

◆ Activation via SADP Software

SADP software is used for detecting the online device, activating the device, and resetting the password.

Get the SADP software from the supplied disk or the official website, and install the SADP software according to the prompts. Follow the steps to activate the camera.

Steps:

1. Run the SADP software to search the online devices.
2. Check the device status from the device list, and select an inactive device.

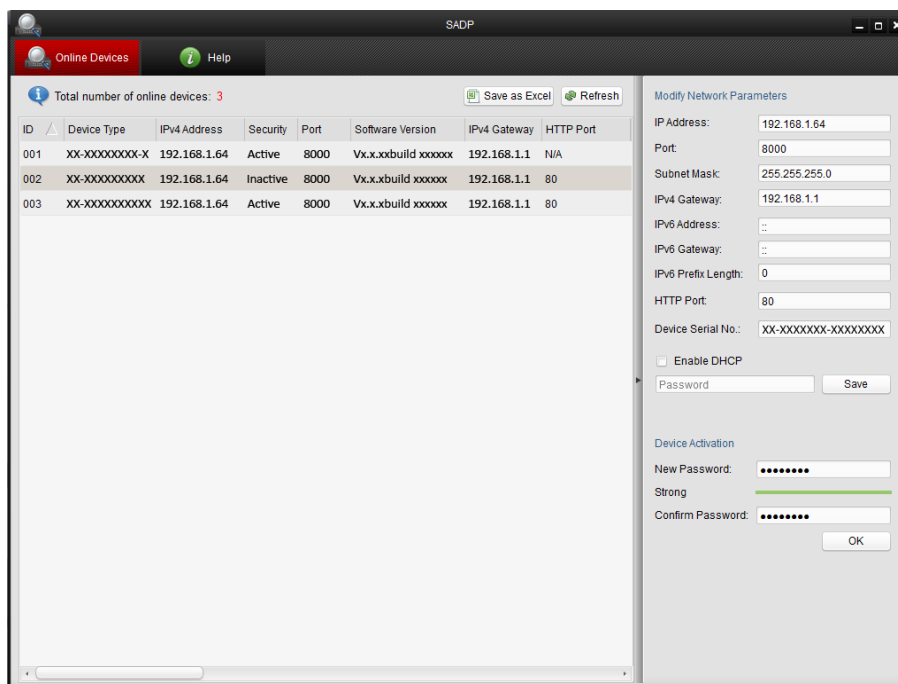

Figure 1-4 SADP Interface

3. Create a password and input the password in the password field, and confirm the password.



STRONG PASSWORD RECOMMENDED— We highly recommend you create a strong password of your own choosing (Using a minimum of 8 characters, including at least three of the following categories: upper case letters, lower case letters, numbers, and special characters.) in order to increase the security of your product. And we recommend you reset your password regularly, especially in the high security system, resetting the password monthly or weekly can better protect your product.

4. Click **OK** to save the password.

You can check whether the activation is completed on the popup window. If activation failed, make sure that the password meets the requirement and then try again.

5. Change the device IP address to the same subnet with your computer by either modifying the IP address manually or checking the **Enable DHCP** checkbox.

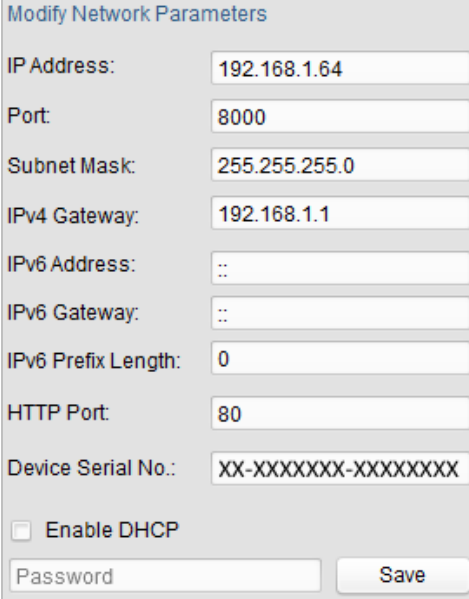

Modify Network Parameters

IP Address: 192.168.1.64

Port: 8000

Subnet Mask: 255.255.255.0

IPv4 Gateway: 192.168.1.1

IPv6 Address: ::

IPv6 Gateway: ::

IPv6 Prefix Length: 0

HTTP Port: 80

Device Serial No.: XX-XXXXXXXX-XXXXXXXX

Enable DHCP

Password Save

Figure 1-5 Modify the IP Address

6. Input the password and click **Save** to activate your IP address modification.

◆ Activation via Client Software

The client software is versatile video management software for multiple kinds of devices. Get the client software from the supplied disk or the official website, and install the software according to the prompts. Follow the steps to activate the camera.

Steps:

1. Run the client software and the control panel of the software pops up, as shown in the figure below.

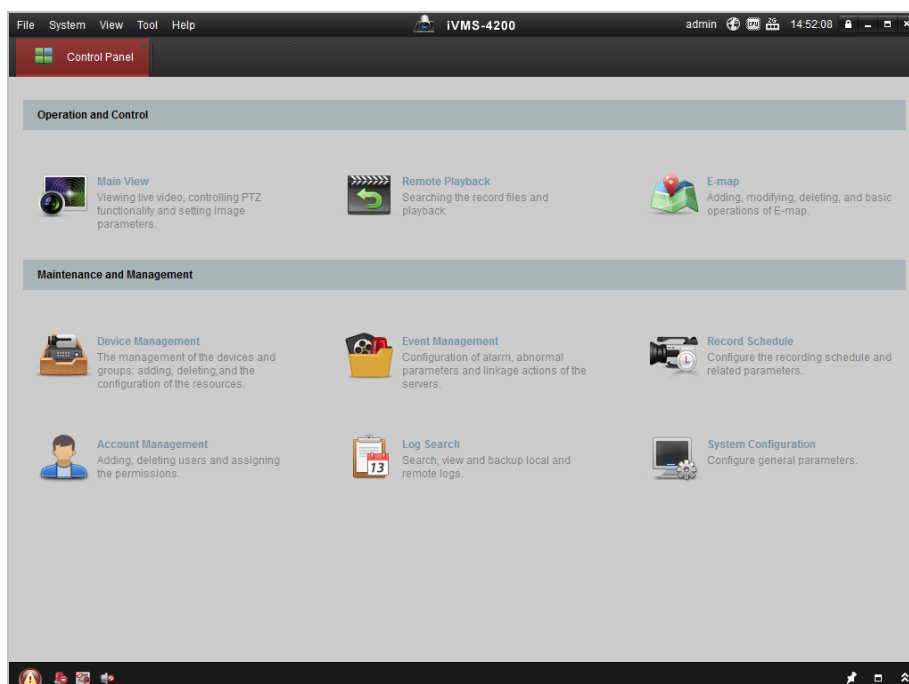

Figure 1-6 Control Panel

- Click **Device Management** to enter the Device Management interface, as shown in the figure below.

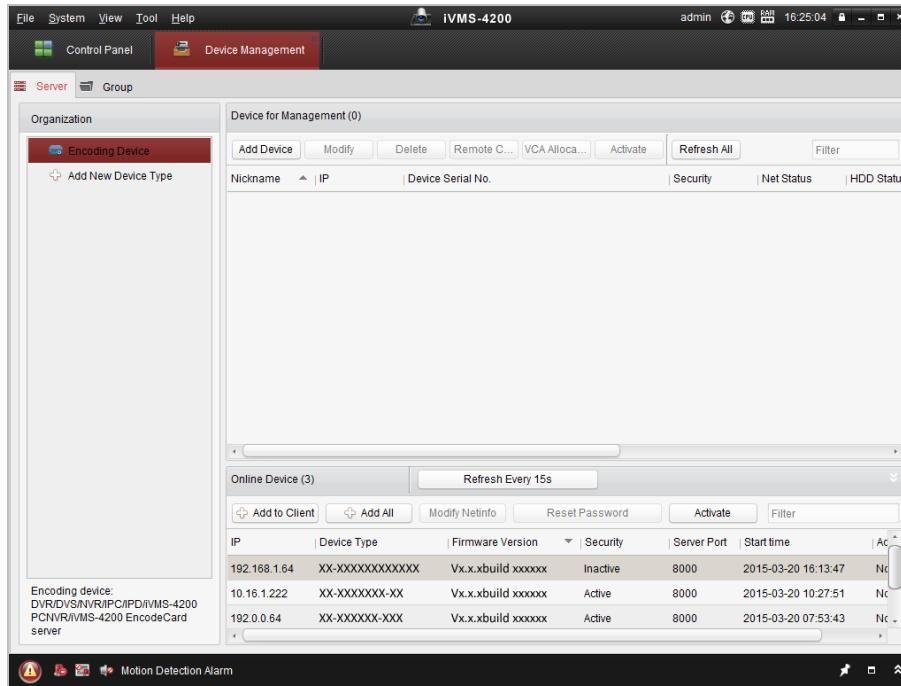

Figure 1-7 Device Management Interface

- Check the device status from the device list, and select an inactive device.
- Click **Activate** to pop up the Activation interface.
- Create a password and input the password in the password field, and confirm the password.



STRONG PASSWORD RECOMMENDED— We highly recommend you create a strong password of your own choosing (Using a minimum of 8 characters, including at least three of the following categories: upper case letters, lower case letters, numbers, and special characters.) in order to increase the security of your product. And we recommend you reset your password regularly, especially in the high security system, resetting the password monthly or weekly can better protect your product.

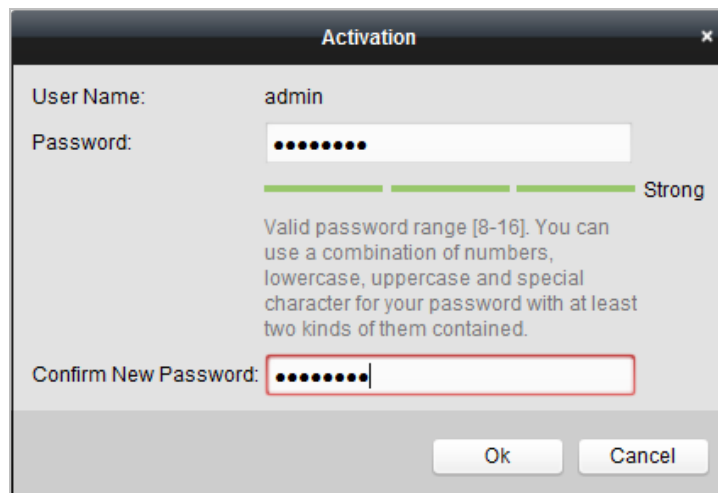

Figure 1-8 Activation Interface

- Click **OK** to start activation.
- Click **Modify Netinfo** to pop up the Network Parameter Modification interface, as shown in the figure below.

Figure 1-9 Modifying the Network Parameters

8. Change the device IP address to the same subnet with your computer by either modifying the IP address manually or checking the **Enable DHCP** checkbox.
9. Input the password to activate your IP address modification.

1.3 Setting the Camera over the WAN (Optional)

Purpose:

This section explains how to connect the camera to the WAN with a static IP or a dynamic IP.

1.3.1 Static IP Connection

Before you start:

Apply a static IP from an ISP (Internet Service Provider). With the static IP address, you can connect the camera via a router or connect it to the WAN directly.

◆ **Connecting the camera via a router**

Steps:

1. Connect the camera to the router.
2. Assign a LAN IP address, the subnet mask and the gateway. Refer to **Section 1.2 Activating the Camera** for detailed IP address configuration of the camera.
3. Save the static IP in the router.
4. Set port mapping, E.g., 80, 8000 and 554 ports. The steps for port mapping vary depending on different routers. Call the router manufacturer for assistance with port mapping.

Note:

Refer to Appendix 2 for detailed information about port mapping.

5. Visit the camera through a web browser or the client software over the internet.

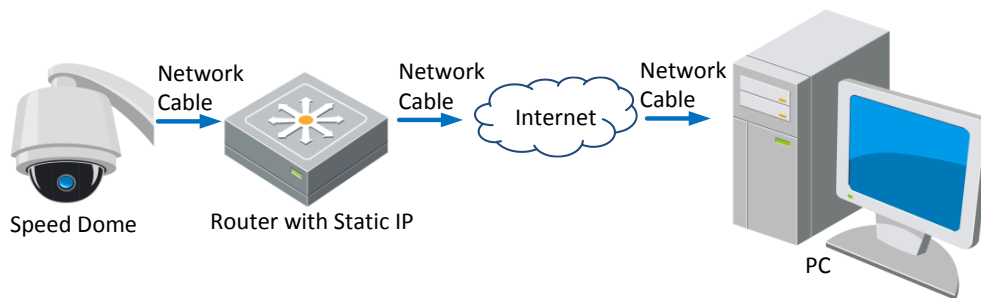

Figure 1-10 Accessing the Camera through Router with Static IP

◆ Connecting the camera with static IP directly

You can also save the static IP in the camera and directly connect it to the internet without using a router. Refer to **Section 1.2 Activating the Camera** for detailed IP address configuration of the camera.

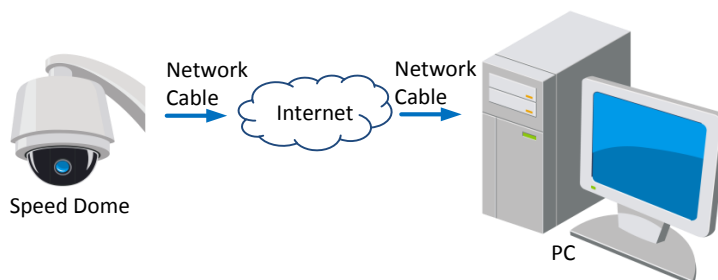

Figure 1-11 Accessing the Camera with Static IP Directly

1.3.2 Dynamic IP Connection

Before you start:

Apply a dynamic IP from an ISP. With the dynamic IP address, you can connect the camera to a modem or a router.

◆ Connecting the camera via a router

Steps:

1. Connect the camera to the router.
2. In the camera, assign a LAN IP address, the subnet mask and the gateway. Refer to **Section 1.2 Activating the Camera** for detailed LAN configuration.
3. In the router, set the PPPoE user name, password and confirm the password.



- *For your privacy and to better protect your system against security risks, we strongly recommend the use of strong passwords for all functions and network devices. The password should be something of your own choosing (Using a minimum of 8 characters, including at least three of the following categories: upper case letters, lower case letters, numbers, and special characters.) in order to increase the security of your product.*
 - *Proper configuration of all passwords and other security settings is the responsibility of the installer and/or end-user.*
4. Set port mapping. E.g. 80, 8000 and 554 ports. The steps for port mapping vary depending on different routers. Call the router manufacturer for assistance with port mapping.

Note:

Refer to Appendix 2 for detailed information about port mapping.

5. Apply a domain name from a domain name provider.
6. Configure the DDNS settings in the setting interface of the router.
7. Visit the camera via the applied domain name.

◆ Connecting the camera via a modem

Purpose:

This camera supports the PPPoE auto dial-up function. The camera gets a public IP address by ADSL dial-up after the camera is connected to a modem. You need to configure the PPPoE parameters of the camera. Refer to **Section 2.2.1 Basic Settings - Configuring PPPoE Settings** for detailed configuration.

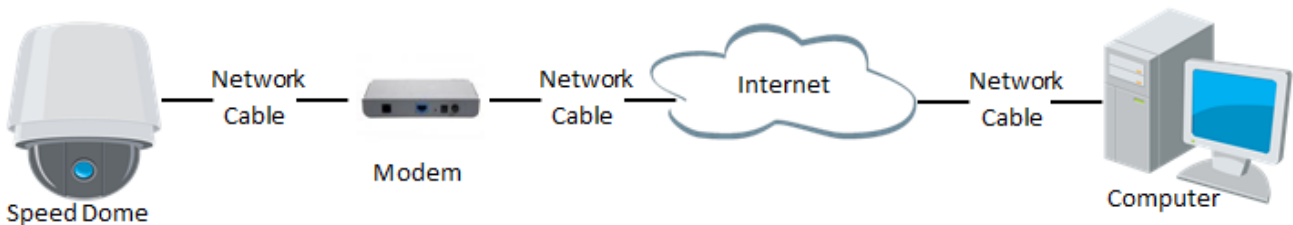

Figure 1-12 Accessing the Camera with Dynamic IP

Note:

The obtained IP address is dynamically assigned via PPPoE, so the IP address always changes after rebooting the camera. To solve the inconvenience of the dynamic IP, you need to get a domain name from the DDNS provider (E.g. DynDns.com). Follow the steps below for normal domain name resolution and private domain name resolution to solve the problem.

◆ Normal Domain Name Resolution

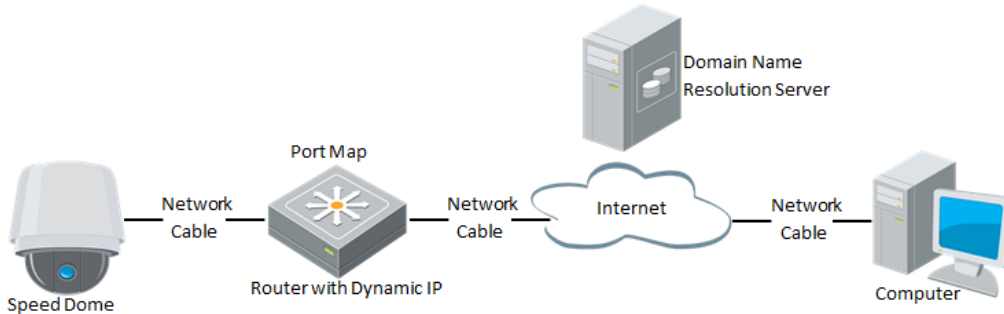

Figure 1-13 Normal Domain Name Resolution

Steps:

1. Apply a domain name from a domain name provider.
2. Configure the DDNS settings in the **DDNS Settings** interface of the camera. Refer to **Section 2.2.1 Basic Settings - Configuring DDNS Settings** for detailed configuration.
3. Visit the camera via the applied domain name.

1.4 Accessing to the Camera

1.4.1 Accessing by Web Browsers

Steps:

1. Open the web browser.

2. In the address field, input the IP address of the camera, e.g., 192.168.1.64 and click **Enter** to enter the login interface.
3. If you activate the camera for the first time using, refer to the **Section 1.2 Activating the Camera**.
4. Select English as the interface language on the top-right of login interface.
5. Input the user name and password and click .

The admin user should configure the device accounts and user/operator permissions properly. Delete the unnecessary accounts and user/operator permissions.

Note:

The device IP address gets locked if the admin user performs 7 failed password attempts (5 attempts for the user/operator).



Figure 1-14 Login Interface

1.4.2 Accessing by Client Software

The product CD contains the client software. You can view the live video and manage the camera with the client software.

Follow the installation prompts to install the client software and. The configuration interface and live view interface of client software are shown below.

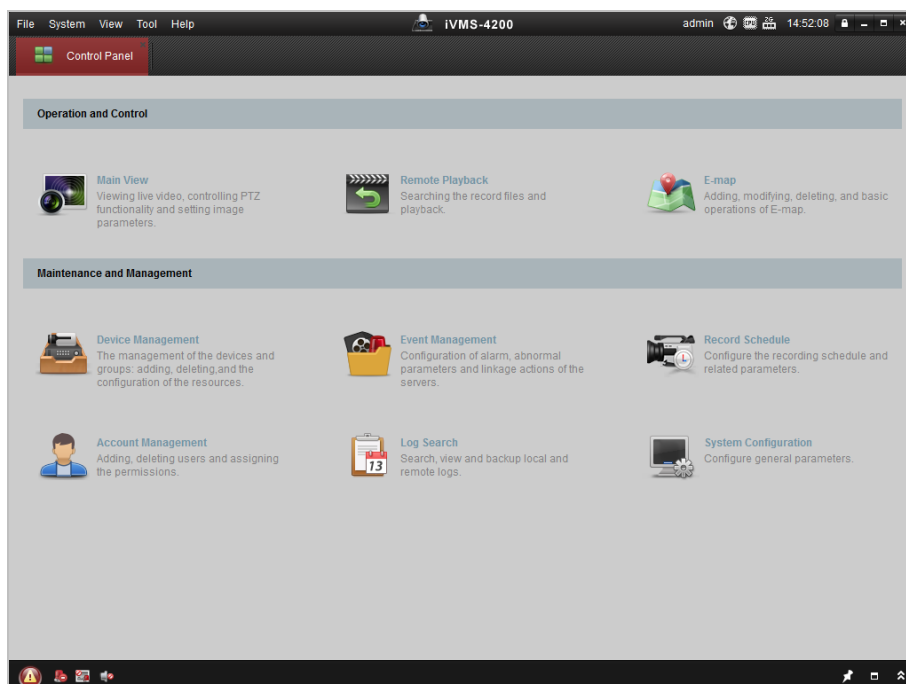

Figure 1-15 iVMS-4200 Control Panel

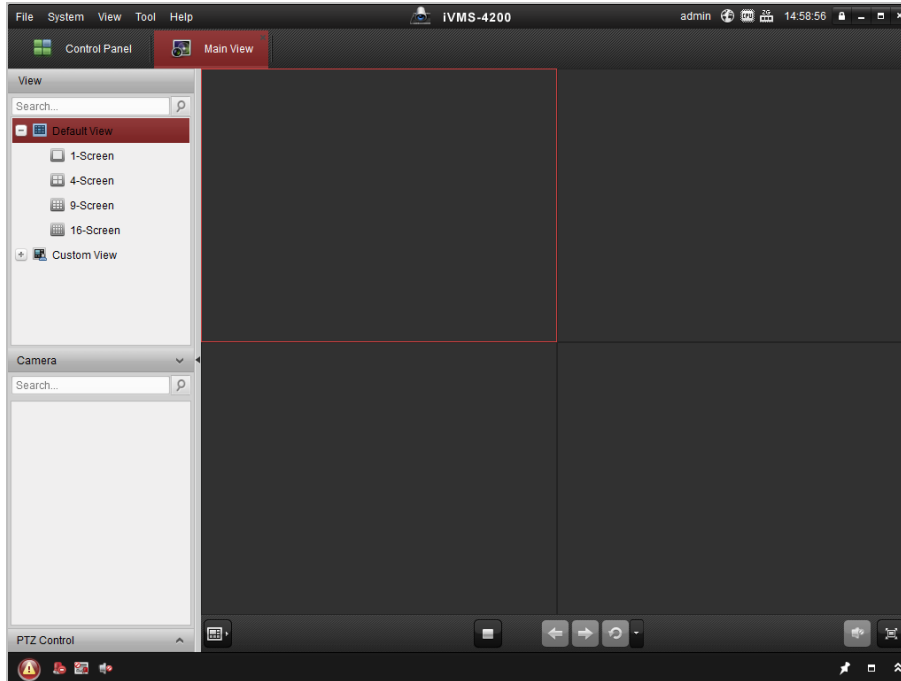

Figure 1-16 iVMS-4200 Live View Interface

Notes:

- If you use third party VMS software, contact technical support of our branch for camera firmware.
- For detailed information about client software of our company, refer to the user manual of the software. This manual mainly introduces accessing to the camera by web browser.

1.5 Power-up Action

After the power is applied, the camera will perform self-test actions. It begins with lens actions and then pan and tilt movement. After the power-up self-test actions, the information shown in Figure 1-17 will be displayed on screen for 40 seconds.

The system information displayed on the screen includes the camera model, address, protocol, version and other information. The COMMUNICATION refers to the baud rate, parity, data bit and stop bit of the camera. e.g., “2400, N, 8, 1” indicates the camera is configured with the baud rate of 2400, no parity, 8 data bits and 1 stop bit.

Model	XX-XXXXXX-X
Address	0
Communication	0000,0,0,0
Software Version	Vx.x.x
Camera Version	Vx.xx
Language	English

Figure 1-17 Power-up Information

Chapter 2 Setting Local Parameters and Network

2.1 Configuring Local Parameters

Note:

The local configuration refers to the parameters of the live view and other operations using the web browser.

Steps:

1. Enter the Local configuration interface:

Configuration > Local

The screenshot shows the 'Local' configuration page in a web browser. On the left is a navigation menu with icons for System, Network, Video/Audio, Image, PTZ, Event, Storage, and VCA. The main content area is titled 'Local' and contains three sections:

- Live View Parameters:**
 - Protocol: TCP, UDP, MULTICAST, HTTP
 - Play Performance: Shortest Delay, Auto
 - Rules: Enable, Disable
 - Image Format: JPEG, BMP
- Record File Settings:**
 - Record File Size: 256M, 512M, 1G
 - Save record files to:
 - Save downloaded files to:
- Picture and Clip Settings:**
 - Save snapshots in live view to:
 - Save snapshots when playback to:
 - Save clips to:

At the bottom of the configuration area is a red 'Save' button.

Figure 2-1 Local Configuration Interface

2. Configure the following settings:

◆ **Live View Parameters:** Set the protocol type, play performance, rules, and image format.

- **Protocol:** TCP, UDP, MULTICAST and HTTP are selectable.

TCP: Ensures complete delivery of streaming data and better video quality, yet the real-time transmission will be affected.

UDP: Provides real-time audio and video streams.





MULTICAST: It's recommended to select the protocol type to Multicast when using the Multicast function. For other information about Multicast, refer to **Section 2.2.1 Basic Settings - Configuring TCP/IP Settings**.

HTTP: Allows the same quality as of TCP without setting specific ports for streaming under some network environments.

- **Play Performance:** Set the live view performance to Shortest Delay or Auto.
- **Rules:** You can enable or disable the rules of dynamic analysis for events here.
- **Image Format:** The captured pictures can be saved in different format. JPEG and BMP are available.

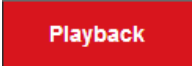
◆ **Record File Settings:** Set the saving path of the video files.

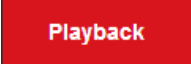
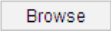
- **Record File Size:** Select the packed size of manually recorded and downloaded video files. The size can be set to 256M, 512M or 1G.

- **Save record files to:** Set the saving path for the manually recorded video files.
 - **Save downloaded files to:** Set the saving path for the downloaded video files in  interface.
 - ◆ **Picture and Clip Settings:** Set the saving paths of the captured pictures and clipped video files.
 - **Save snapshots in live view to:** Set the saving path of the manually captured pictures in  interface.
 - **Save snapshots when playback to:** Set the saving path of the captured pictures in  interface.
 - **Save clips to:** Set the saving path of the clipped video files in  interface.
- Note:**
You can click  to change the directory for saving video files, clips and pictures.
3. Click  to save the settings.

2.2 Configuring Network Settings

2.2.1 Basic Settings

Configuring TCP/IP Settings

Purpose:

TCP/IP settings must be properly configured before you operate the camera over network. IPv4 and IPv6 are both supported.

Steps:

1. Enter TCP/IP settings interface:
Configuration > Network > Basic Settings > TCP/IP

TCP/IP	DDNS	PPPoE	Port	NAT
NIC Type	Auto			
	<input type="checkbox"/> DHCP			
IPv4 Address	10.16.1.93			Test
IPv4 Subnet Mask	255.255.255.0			
IPv4 Default Gateway	10.16.1.254			
IPv6 Mode	Route Advertisement			View Route Advertisement
IPv6 Address	::			
IPv6 Subnet Mask	0			
IPv6 Default Gateway	::			
Mac Address	c0:56:e3:b3:bc:c0			
MTU	1500			
Multicast Address				
	<input checked="" type="checkbox"/> Enable Multicast Discovery			
	<input type="checkbox"/> Enable Active Multicast			
Multicast Stream	Main Stream			
Multicast Address	0.0.0.0			
Multicast Port	60000			
DNS Server				
Preferred DNS Server	8.8.8.8			
Alternate DNS Server				

Figure 2-2 TCP/IP Settings

- Configure the basic network settings, including the NIC Type, IPv4 or IPv6 Address, IPv4 or IPv6 Subnet Mask, IPv4 or IPv6 Default Gateway, MTU settings and Multicast Address.
- (Optional) Check the **Enable Multicast Discovery** checkbox, and then the online network camera can be automatically detected by client software via private multicast protocol in the LAN.
- Configure the DNS server. Input the preferred DNS server, and alternate DNS server.
- Click  to save the above settings.

Notes:

- The valid value range of MTU is 1280 ~ 1500.
- The Multicast sends a stream to the multicast group address and allows multiple clients to acquire the stream at the same time by requesting a copy from the multicast group address. Before utilizing this function, you have to enable the Multicast function of your router.
- Reboot the device before the settings take effect.

Configuring DDNS Settings**Purpose:**

If your camera is set to use PPPoE as its default network connection, you can use the Dynamic DNS (DDNS) for network access.

Before you start:

Registration on the DDNS server is required before configuring the DDNS settings of the camera.



- For your privacy and to better protect your system against security risks, we strongly recommend the use of strong passwords for all functions and network devices. The password should be

something of your own choosing (Using a minimum of 8 characters, including at least three of the following categories: upper case letters, lower case letters, numbers, and special characters.) in order to increase the security of your product.

- Proper configuration of all passwords and other security settings is the responsibility of the installer and/or end-user.

Steps:

1. Enter the DDNS settings interface:

Configuration > Network > Basic Settings > DDNS

Figure 2-3 DDNS Settings

2. Check the **Enable DDNS** checkbox to enable this feature.
3. Select **DDNS Type**. Two DDNS types are selectable: DynDNS and NO-IP.

- **DynDNS:**

Steps:

- (1) Input **Server Address** of DynDNS (e.g. members.dyndns.org).
- (2) In the **Domain** text field, input the domain name obtained from the DynDNS website.
- (3) Input the **Port** of DynDNS server.
- (4) Input the **User Name** and **Password** registered on the DynDNS website.

- (5) Click  to save the settings.

Figure 2-4 DynDNS Settings

- **NO-IP:**

Steps:

- (1) Input **Server Address** of NO-IP.
- (2) In the **Domain** text field, input the domain name obtained from the NO-IP website.
- (3) Input the **Port** of NO-IP server.
- (4) Input the **User Name** and **Password** registered on the NO-IP website.

- (5) Click  to save the settings.

Configuring PPPoE Settings

Purpose:

If you have no router but only a modem, you can use Point-to-Point Protocol over Ethernet (PPPoE) function.

Steps:

1. Enter the PPPoE settings interface:

Configuration > Network > Basic Settings > PPPoE



<input checked="" type="checkbox"/> Enable PPPoE	
Dynamic IP	0.0.0.0
User Name	
Password	
Confirm	

Figure 2-5 PPPoE Settings

2. Check the **Enable PPPoE** checkbox to enable this feature.
3. Input **User Name**, **Password**, and **Confirm** password for PPPoE access.

Note:

The User Name and Password should be assigned by your ISP.



- *For your privacy and to better protect your system against security risks, we strongly recommend the use of strong passwords for all functions and network devices. The password should be something of your own choosing (Using a minimum of 8 characters, including at least three of the following categories: upper case letters, lower case letters, numbers, and special characters.) in order to increase the security of your product.*
- *Proper configuration of all passwords and other security settings is the responsibility of the installer and/or end-user.*

4. Click  to save and exit the interface.

Configuring Port Settings

Purpose:

If there is a router and you want to access the camera through Wide Area Network (WAN), you need to forward the 3 ports for the camera.

Steps:

1. Enter the Port settings interface:

Configuration > Network > Basic Settings > Port

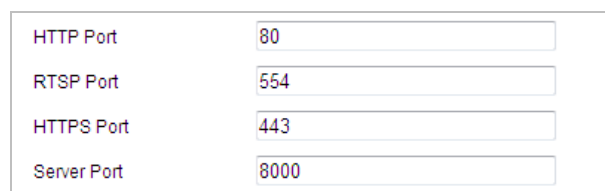

HTTP Port	80
RTSP Port	554
HTTPS Port	443
Server Port	8000

Figure 2-6 Port Settings

- Set the HTTP port, RTSP port, HTTPS port and port of the camera.

HTTP Port: The default port number is 80.

RTSP Port: The default port number is 554.

HTTPS Port: The default port number is 443.

Server Port: The default port number is 8000.

- Click  to save the settings.

Configuring NAT (Network Address Translation) Settings

Purpose:

Universal Plug and Play (UPnP™) is a networking architecture that provides compatibility among networking equipment, software and other hardware devices. The UPnP protocol allows devices to connect seamlessly and to simplify the implementation of networks in the house and corporate environments.

With the function enabled, you don't need to configure the port mapping for each port, and the camera is connected to the Wide Area Network via the router.

Steps:

- Enter the NAT settings interface by
Configuration > Network > Basic Settings > NAT
- Check the **Enable UPnP™** checkbox to enable the UPnP™ function.
- Set the port mapping mode:

To port mapping with the default port numbers:

Choose **Port Mapping Mode**

To port mapping with the customized port numbers:

Choose **Port Mapping Mode**

And you can customize the value of the port No. by yourself.

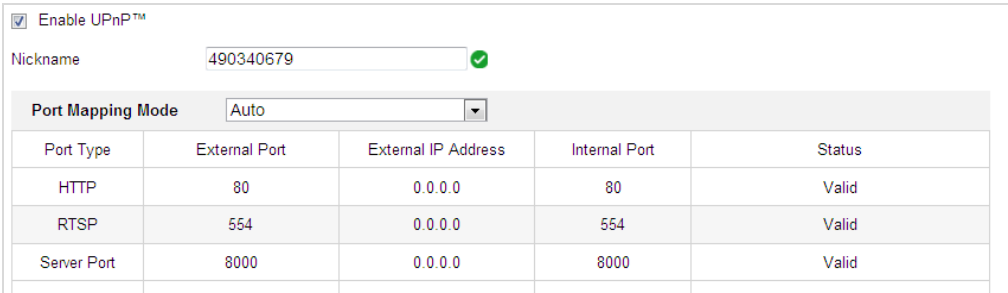

Enable UPnP™

Nickname 

Port Mapping Mode

Port Type	External Port	External IP Address	Internal Port	Status
HTTP	80	0.0.0.0	80	Valid
RTSP	554	0.0.0.0	554	Valid
Server Port	8000	0.0.0.0	8000	Valid

Figure 2-7 Configure the Port No.

- Click  to save the settings.

2.2.2 Advanced Settings

Configuring SNMP Settings

Purpose:

You can use SNMP to get camera status and parameters related information.

Before you start:

Before setting the SNMP, use the SNMP software and manage to receive the camera information via SNMP port. By setting the Trap Address, the camera can send the alarm event and exception messages to the surveillance center.

Note:

The SNMP version you select should be the same as that of the SNMP software.

Steps:

1. Enter the SNMP settings interface:

Configuration > Network > Advanced Settings > SNMP

The screenshot displays the SNMP configuration interface, organized into three main sections:

- SNMP v1/v2:**
 - Enable SNMPv1
 - Enable SNMP v2c
 - Read SNMP Community: public
 - Write SNMP Community: private
 - Trap Address: (empty)
 - Trap Port: 162
 - Trap Community: public
- SNMP v3:**
 - Enable SNMPv3
 - Read UserName: (empty)
 - Security Level: no auth, no priv
 - Authentication Algorithm: MDS SHA
 - Authentication Password: (masked)
 - Private-key Algorithm: DES AES
 - Private-key password: (masked)
 - Write UserName: (empty)
 - Security Level: no auth, no priv
 - Authentication Algorithm: MDS SHA
 - Authentication Password: (masked)
 - Private-key Algorithm: DES AES
 - Private-key password: (masked)
- SNMP Other Settings:**
 - SNMP Port: 161

Figure 2-8 SNMP Settings

2. Check the corresponding version checkbox (**Enable SNMP v1**, **Enable SNMP v2c**, **Enable SNMP v3**) to enable the feature.
3. Configure the SNMP settings.

Note:

The configuration of the SNMP software should be the same as the settings you configure here.

4. Click  to save and finish the settings.

Configuring FTP Settings

Purpose:

You can set a FTP server and configure the following parameters for uploading captured pictures.

Steps:

1. Enter the FTP settings interface:

Configuration > Network > Advanced Settings > FTP

Figure 2-9 FTP Settings

2. Configure the FTP settings, including server address, port, user name, password, directory, and upload type.



- *For your privacy and to better protect your system against security risks, we strongly recommend the use of strong passwords for all functions and network devices. The password should be something of your own choosing (Using a minimum of 8 characters, including at least three of the following categories: upper case letters, lower case letters, numbers, and special characters.) in order to increase the security of your product.*
- *Proper configuration of all passwords and other security settings is the responsibility of the installer and/or end-user.*

The server address supports both the domain name and IP address formats.

- **Setting the directory in FTP server for saving files:**

In the **Directory Structure** field, you can select the root directory, parent directory and child directory.

- **Root directory:** The files will be saved in the root of FTP server.
- **Parent directory:** The files will be saved in a folder in FTP server. The name of folder can be defined as shown in following Figure 2-10.

Figure 2-10 Parent Directory

- **Child directory:** It is a sub-folder which can be created in the parent directory. The files will be saved in a sub-folder in FTP server. The name of folder can be defined as shown in following Figure 2-11.

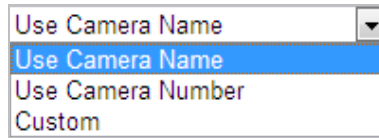

Figure 2-11 Child Directory

- **Upload type:** To enable uploading the captured picture to the FTP server.

3. Click  to save the settings.

Note:

If you want to upload the captured pictures to FTP server, you also have to enable the continuous snapshot or event-triggered snapshot in **Snapshot** interface. For detailed information, refer to the **Section 5.1.4 Configuring Capture Schedule**.

Configuring Email Settings

Purpose:

The system can be configured to send an Email notification to all designated receivers if an alarm event is detected, e.g., motion detection event, video loss, video tampering, etc.

Before you start:

Configure the DNS Server settings under **Configuration > Network > Basic Settings > TCP/IP** before using the Email function.

Steps:

1. Enter the Email settings interface:

Configuration > Network > Advanced Settings > Email

Sender	<input type="text"/>
Sender's Address	<input type="text"/>
SMTP Server	<input type="text"/>
SMTP Port	25
E-mail Encryption	None
<input type="checkbox"/> Authentication	
User Name	<input type="text"/>
Password	<input type="text"/>
Confirm	<input type="text"/>

Receiver			
No.	Receiver	Receiver's Address	Test
1			<input type="button" value="Test"/>
2			
3			



Figure 2-12 Email Settings

2. Configure the following settings:

Sender: The name of the email sender.

Sender's Address: The email address of the sender.

SMTP Server: The SMTP Server IP address or host name (e.g., smtp.263xmail.com).

SMTP Port: The SMTP port. The default TCP/IP port for SMTP is 25.

E-mail Encryption: Email encryption can be selected among None and SSL. When SSL is selected, you can check the **Enable STARTTLS** checkbox to encrypt the email with STARTTLS and the SMTP port No. is 25. You can uncheck the **Enable STARTTLS** checkbox to encrypt the email with SSL and the SMTP should be set as 465.

Note:

STARTTLS protocol must be supported by the email server for email encryption with STARTTLS. When it is not supported by the email server and the Enable STARTTLS checkbox is checked, the email will not be encrypted.

Authentication (optional): If your email server requires authentication, check this checkbox to use authentication to log in to this server and input the login user name and password.



- *For your privacy and to better protect your system against security risks, we strongly recommend the use of strong passwords for all functions and network devices. The password should be something of your own choosing (Using a minimum of 8 characters, including at least three of the following categories: upper case letters, lower case letters, numbers, and special characters.) in order to increase the security of your product.*
- *Proper configuration of all passwords and other security settings is the responsibility of the installer and/or end-user.*

Receiver: Input the receiver to which the email is sent.

Receiver's Address: The email address of user to be notified.

Note:

You can click  to check whether the setting is invalid after the required parameters are configured.

3. Click  to save the settings.

Configuring HTTPS Settings

Purpose:

HTTPS provides authentication of the web site and associated web server that one is communicating with, which protects against Man-in-the-middle attacks. Perform the following steps to set the port number of https.

Example:

If you set the port number as 443 and the IP address is 192.168.1.64, you may access the device by inputting `https://192.168.1.64:443` via the web browser.

Steps:

1. Enter the HTTPS settings interface.
Configuration > Network > Advanced Settings > HTTPS
2. Create the self-signed certificate or authorized certificate.

Figure 2-13 Create Certificate

OPTION 1: Create the self-signed certificate

- 1) Select **Create Self-signed Certificate**.
- 2) Click **Create** to create the following dialog box.

Figure 2-14 Create Self-signed Certificate

- 3) Input the country, host name/IP, validity and other information.
- 4) Click **OK** to save the settings.

OPTION 2: Start the installation when signed certificate is available.

- 1) Select **Signed certificate is available, Start the installation directly**.
- 2) Click **Browse** to upload the available certificate.
- 3) Click **Install** button to install the certificate.
- 4) Click **OK** to save the settings.

OPTION 3: Create certificate request first and continue the installation.

- 1) Select **Create certificate request first and continue the installation**.
- 2) Click **Create** to create the certificate request, and fulfill the required information.
- 3) Download the certificate request and submit it to the trusted certificate authority for signature.
- 4) After receiving the signed valid certificate, import the certificate to the device.
- 5) Click **OK** to save the settings.

3. There will be the certificate information after you successfully create and install the certificate.

Figure 2-15 Installed Certificate Property

Note:

You can click configure the HTTPS port No. on your demand; refer to **Section 2.2.1 Basic Settings - Configuring Port Settings** for details.

4. Check the **Enable HTTPS** checkbox and click **Save**.

Configuring QoS Settings

Purpose:

QoS (Quality of Service) can help solve the network delay and network congestion by configuring the priority of data sending.

Steps:

1. Enter the QoS settings interface:

Configuration > Network > Advanced Settings > QoS

Video/Audio DSCP	<input type="text" value="0"/>
Event/Alarm DSCP	<input type="text" value="0"/>
Management DSCP	<input type="text" value="0"/>

Figure 2-16 QoS Settings

2. Configure the QoS settings, including video/audio DSCP, event/alarm DSCP and Management DSCP. The valid DSCP value ranges from 0 to 63. The DSCP value is bigger, the priority is higher.
3. Click  to save the settings.

Notes:

- Make sure that you enable the QoS function of your network device (such as a router).
- Reboot the device before the settings take effect.

Configuring 802.1X Settings

Purpose:

The camera supports IEEE 802.1X standard.

IEEE 802.1X is a port-based network access control. It enhances the security level of the LAN. When devices connect to this network with IEEE 802.1X standard, the authentication is needed. If the authentication fails, the devices don't connect to the network.

The protected LAN with 802.1X standard is shown as follows:

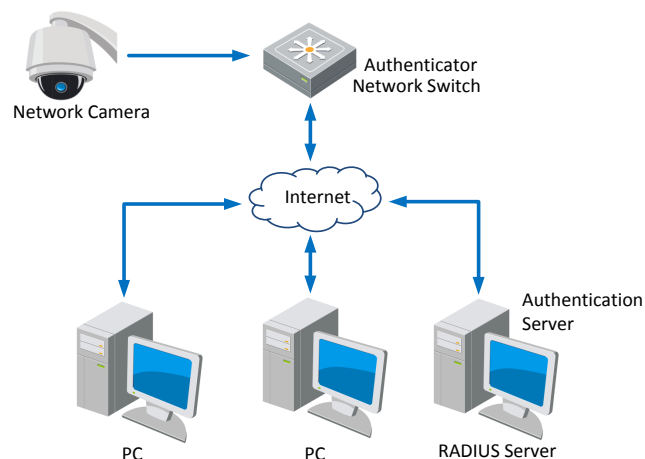

Figure 2-17 Protected LAN

- Before connecting the network camera to the protected LAN, apply a digital certificate from a Certificate Authority.
- The network camera requests access to the protected LAN via the authenticator (a switch).
- The switch forwards the identity and password to the authentication server (RADIUS server).
- The switch forwards the certificate of authentication server to the network camera.
- If all the information is validated, the switch allows the network access to the protected network.



- *For your privacy and to better protect your system against security risks, we strongly recommend the use of strong passwords for all functions and network devices. The password should be something of your own choosing (Using a minimum of 8 characters, including at least three of the following categories: upper case letters, lower case letters, numbers, and special characters.) in order to increase the security of your product.*
- *Proper configuration of all passwords and other security settings is the responsibility of the installer and/or end-user.*

Steps:

1. Connect the network camera to your PC directly with a network cable.
2. Enter the 802.1X settings interface:

Configuration > Network > Advanced Settings > 802.1X

<input checked="" type="checkbox"/> Enable IEEE 802.1X	
Protocol	EAP-MD5
EAPOL version	1
User Name	
Password	
Confirm	

Figure 2-18 802.1X Settings

3. Check the **Enable IEEE 802.1X** checkbox to enable it.
4. Configure the 802.1X settings, including user name and password.

Note:

The EAP-MD5 version must be identical with that of the router or the switch.

5. Click  to finish the settings.

Note:

The camera reboots when you save the settings.

6. After the configuration, connect the camera to the protected network.

Chapter 3 Live View

3.1 Install the Plug-in

Install the plug-in before viewing the live video and operating the camera. Follow the installation prompts to install the plug-in.

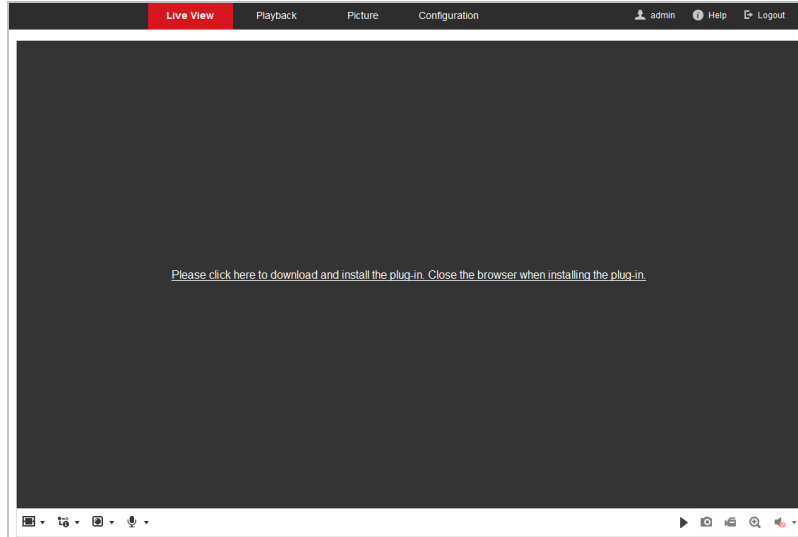



Figure 3-1 Download and Install Plug-in

Notes:

- You may have to close the web browser to install the plug-in. Reopen the web browser and log in again after installing the plug-in.
- To select the plug-in type, you can click  on live view interface. For detailed information, refer to **Section 3.2.2 Live View Operation**.

3.2 Live View Page

3.2.1 Descriptions of the live view page:

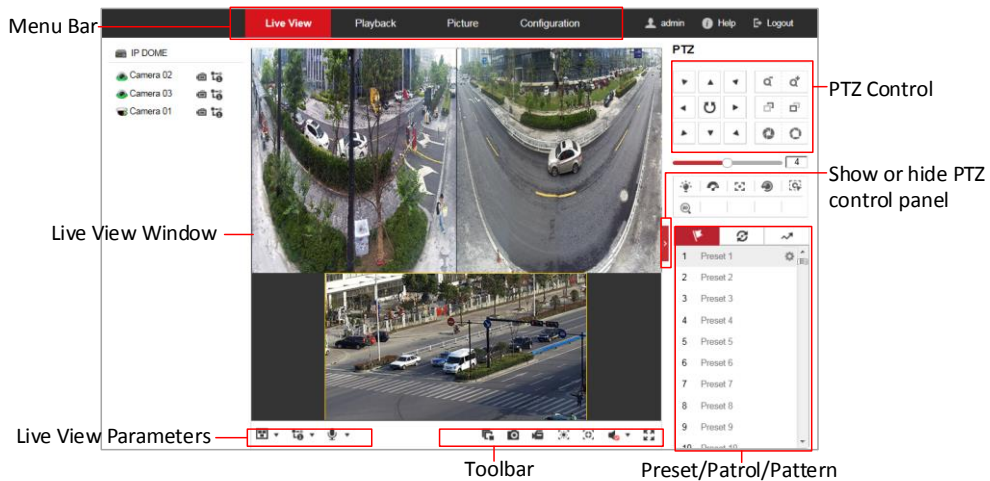



Figure 3-2 Live View Page

Menu Bar:

Click each tab to enter Live View, Playback, Picture, and Configuration page respectively.

Click  to display the help file of the camera.

Click  to logout the system.

Live View Window:

Display the live video.

Toolbar:

Operations on the live view page, e.g., live view, capture, record, audio on/off, regional exposure, regional focus, etc.

PTZ Control:

Panning, tilting, focusing and zooming actions of the camera. The lighter, wiper, one-touch focus and lens initialization control.

Preset/patrol/pattern:

Set and call the preset/patrol/pattern for the camera.

Live View Parameters:

Configure the window division, image size, stream type, plug-in type, and two-way audio of the live video.

3.2.2 Live View Operation

Purpose:

The live video page allows you to view live video, capture images, realize PTZ control, set/call presets and configure video parameters.

Log in the camera to enter the live view page, or you can click **Live View** on the menu bar of the main page to enter the live view page.

Starting Live View

Click  on the toolbar to start the live view of all channels of the network camera. Live view page of panoramic + PTZ camera and panoramic camera are different as shown below.

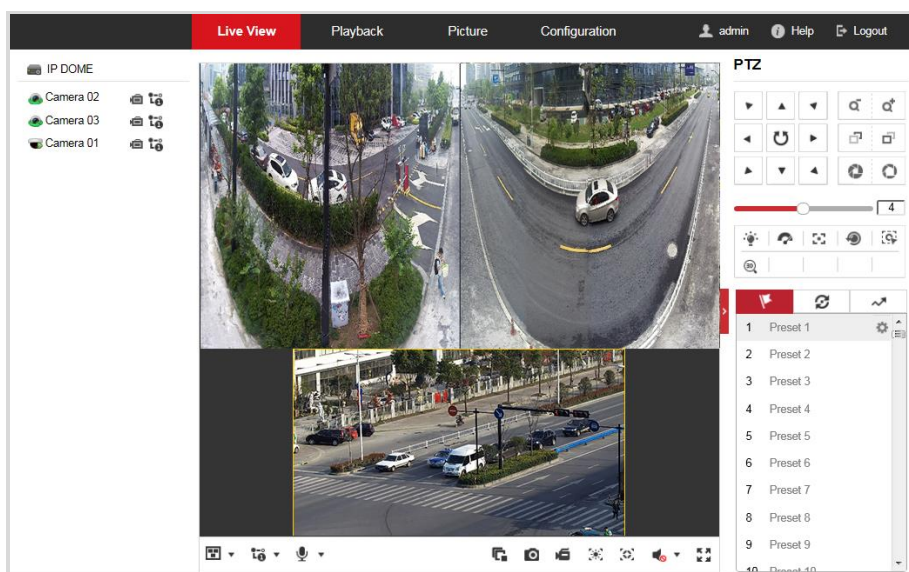

Figure 3-3 Start Live View (Panoramic + PTZ Camera)

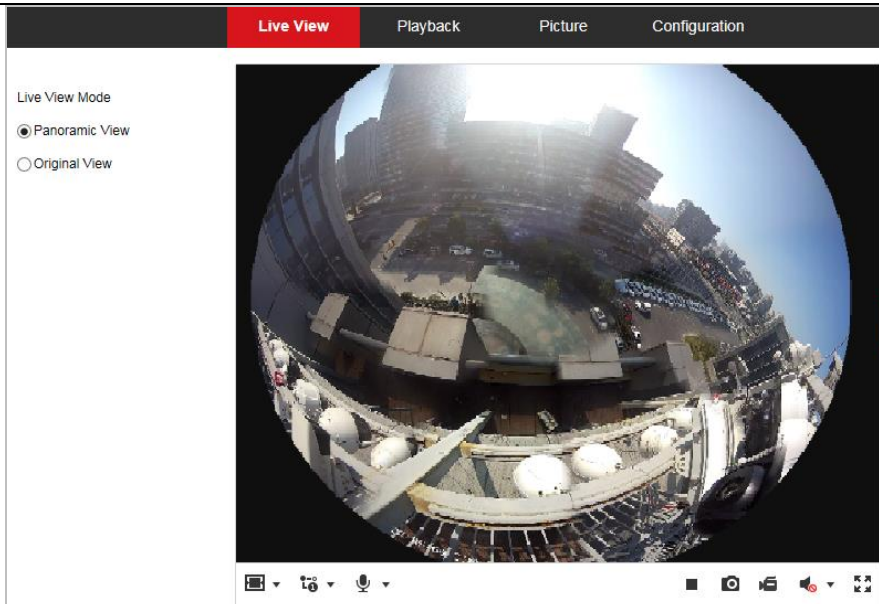

Figure 3-4 Start Live View (Panoramic Camera)

Descriptions of Icons on Toolbar and Live View Interface are listed below:

Live View / Click to start all live views and the icon turns into . Click the icon again to stop all live views.

Full-screen Double-click on the live video to switch the current live view into full-screen or return to normal mode from the full-screen.

Record/Capture Click to manual capture the picture.

/ Click to start manual recording and the icon turns into . Click the icon again to stop recording.

Note: Before perform manual recording and manual capture, configure the saving path of files referring to **Section 2.1 Local Configuration Interface**.

Window Division For 360° panoramic + PTZ camera, click to select from and display live video in triple-row/double-row/1x1 window size.

For 180° panoramic + PTZ camera, click to select from and display live video in double-row/1x1 window size.



























Note:

When you select 1x1 window size, it plays live view of camera 1 only.



For panoramic camera, click to select from , and display live video in 1x1/2x2/3x3/4x4 division mode.

Stream Type / / Click to select from and display live video with the main/sub/third stream. The main stream is with a relatively high resolution and needs much bandwidth. The sub-stream is with a low resolution and



needs less bandwidth. The resolution of third stream is between that of main stream and sub stream. The default setting of stream type is .













Plug-in Switch	 / 	Click  to select between   and play the live video via player Webcomponents or Quick Time. The live video is played via webcomponents by default, and other types of players are supported for the browser, such as MJPEG, and VLC. You are required to download and install the player to play the live video.
Audio	 / 	<p>Volume</p> <p>Click  to display the . Drag the slider to adjust the volume.</p>
	 / 	<p>Two-way Audio</p> <p>Click  and it displays . Click  to enable two-way audio and the icon turns into . Click the icon again to stop two-way audio.</p> <p>Note:</p> <p>Before enabling the two-way audio or recording with audio functions, set the Stream Type to Video & Audio referring to Section 3.4.1 Configuring Video Settings.</p>
Digital Zoom	 / 	Click  to enable digital zoom function and the icon turns into  . Then drag the mouse towards low right direction to draw a rectangle on the image as the desired zoom. After viewing it you can click any place of the picture to get back to normal picture.
Regional Exposure	 / 	Click  on the toolbar to enter the regional exposure operation mode and the icon turns into  . Then drag the mouse to draw a rectangle on the image as the desired exposure region.
Regional Focus	 / 	Click  on the toolbar to enter the regional focus operation mode and the icon turns into  . Then drag the mouse to draw a rectangle on the image as the desired focus region.

PTZ Control Panel

On the live view page, click  to show the PTZ control panel or click  to hide it.

Descriptions of Icons on PTZ Control Panel are listed below:

PTZ Control		<p>Hold the direction buttons to control the pan/tilt movements.</p> <p>Click  and the camera keeps panning, the icon turns into . Click the icon again to stop the camera.</p>
--------------------	---	---

Zoom		Click  , the lens zooms in, click  , and the lens zooms out.
Focus		Click  , the lens focus far and the items far away gets clear. Click  , the lens focus near and the items nearby gets clear.
Iris		When the image is too dark, click  to open the iris. When the image is too bright, click  to close the iris.
Adjust Speed		Adjust speed of pan/tilt movements.
Preset		Refer to 4.1.1 for detailed information of setting preset.
Patrol		Refer to 4.1.2 for detailed information of setting patrol.
Pattern		Refer to 4.1.3 for detailed information of setting pattern.

Note:

PTZ functions, including PTZ control, preset, patrol, and pattern are only supported by camera 1.

Auxiliary Functions









The auxiliary functions include light, wiper, auxiliary focus, lens initialization, manual tracking, 3D positioning, one-touch patrol, and one-touch park.

The Auxiliary functions panel is shown in the figure below:



Figure 3-5 Auxiliary Functions

Descriptions of Icons on PTZ Control Panel are listed below:

Light Supplement		Click  to enable/disable the light supplement of the camera. This function is reserved.
Wiper		Click  to move the wiper once.
Auxiliary Focus		The auxiliary focus function is reserved.
Manual Tracking		<p>Before you start:</p> <p>Enter the Smart Tracking settings interface and enable smart tracking first.</p> <p>Configuration > PTZ > Smart Tracking</p> <p>Steps:</p> <ol style="list-style-type: none"> 1. Click  on the toolbar of live view interface. 2. Click a moving object in the live video. The camera will track the object automatically.
3D Positioning		<p>Steps:</p> <ol style="list-style-type: none"> 1. Click  on the toolbar of live view interface. 2. Operate the 3D positioning function: <ul style="list-style-type: none"> ● Left click a position of the live video. The corresponding position will be moved to the

center of the live video.

- Hold down the left mouse button and drag the mouse to the lower right on the live video. The corresponding position will be moved to the center of the live video and zoomed in.
- Hold down the left mouse button and drag the mouse to the upper left on the live video. The corresponding position will be moved to the center of the live video and zoomed out.

Note:

When you perform 3D positioning on Camera 2 or Camera 3, the Camera 1 will move to the corresponding position.

3.3 Configuring Image Settings

3.3.1 Configuring Display Settings

Purpose:

You can set the image quality of the camera, including brightness, contrast, saturation, sharpness, etc.

Notes:

- The parameters in **Display Settings** interface vary depending on different camera models.
- You can double click the live view to enter full screen mode and double click it again to exit.

Steps:

1. Enter the Display Settings interface:
Configuration > Image > Display Settings
2. Select channel No. of the camera.
3. You can select the **Mounting Scenario** from the dropdown list with different predefined image parameters.
4. Set the image parameters of the camera.

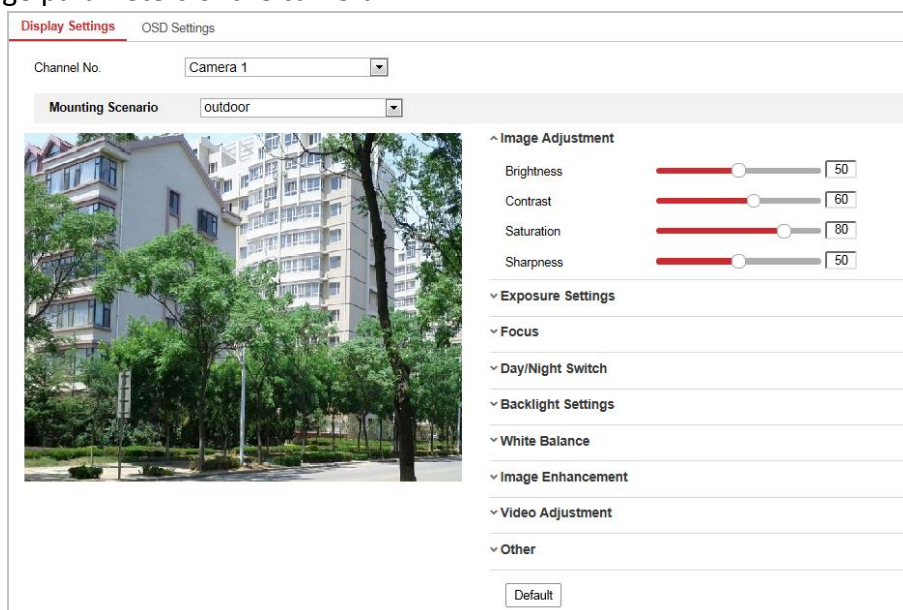

Figure 3-6 Display Settings

Image Adjustment

- **Brightness**

This feature is used to adjust brightness of the image. The value ranges from 0 to 100.

- **Contrast**

This feature enhances the difference in color and light between parts of an image. The value ranges from 0 to 100.

- **Saturation**

This feature is used to adjust color saturation of the image. The value ranges from 0 to 100.

- **Sharpness**

Sharpness function enhances the detail of the image by sharpening the edges in the image. The value ranges from 0 to 100.

Exposure Settings

- **Exposure Mode**

The **Exposure Mode** can be set to **Auto**, **Iris Priority**, **Shutter Priority**, and **Manual**.

- **Auto:**

The iris, shutter and gain values will be adjusted automatically according to the brightness of the environment.

- **Iris Priority:**

The value of iris needs to be adjusted manually. The shutter and gain values will be adjusted automatically according to the brightness of the environment.

Exposure Mode	Iris Priority
Max. Shutter Limit	1/25
Min. Shutter Limit	1/30000
Iris	f2.4
Limit Gain	88
Slow Shutter	OFF

Figure 3-7 Manual Iris

- **Shutter Priority:**

The value of shutter needs to be adjusted manually. The iris and gain values will be adjusted automatically according to the brightness of the environment.

Exposure Mode	Shutter Priority
Max. Iris Limit	100
Min. Iris Limit	0
Shutter	1/50
Limit Gain	88
Slow Shutter	OFF

Figure 3-8 Manual Shutter

- **Manual:**

In **Manual** mode, you can adjust the values of **Gain**, **Shutter**, **Iris** manually.

Note:

This function varies depending on different camera models.

- **Limit Gain**

This feature is used to adjust gain of the image. The value ranges from 0 to 100.

- **Slow Shutter**

This function can be used in underexposure condition. It lengthens the shutter time to ensure full exposure. Select slow shutter level from the dropdown list

Slow Shutter	ON
Slow Shutter Level	Slow Shutter*2

Figure 3-9 Slow Shutter

Focus Settings

- **Focus Mode**

The **Focus Mode** can be set to **Auto**, **Manual**, **Semi-auto**.

- **Auto:**

The camera focuses automatically at any time according to objects in the scene.

- **Semi-auto:**

The camera focuses automatically only once after panning, tilting and zooming.

- **Manual:**

In **Manual** mode, you need to use   on the control panel to focus manually.

- **Min. Focus Distance**

This function is used to limit the minimum focus distance.

Note:

Focus settings applies only to Camera 1.

Day/Night Switch

- **Day/Night Switch**

The **Day/Night Switch** mode can be set to **Auto**, **Day**, **Night**, and **Scheduled-Switch**.

- **Auto:**

In **Auto** mode, the day mode and night mode can switch automatically according to the light condition of environment. The switching sensitivity can be set to **Low**, **Normal**, **High**.

Day/Night Switch	Auto
Sensitivity	2

Figure 3-10 Auto Mode Sensitivity

- **Day:**

In **Day** mode, the camera displays color image. It is used for normal lighting conditions.

- **Night:**

In **Night** mode, the image is black and white. **Night** mode can increase the sensitivity in low light conditions.

- **Scheduled-Switch**

In **Scheduled-Switch** mode, you can set the time schedule for day mode as shown in Figure 3-11. The rest time out of the schedule is for night mode.

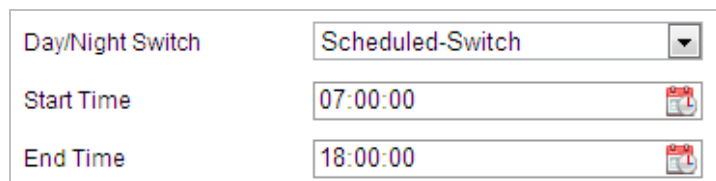

Figure 3-11 Day Night Schedule

- **Smart Supplement Light**

If the light supplement is on and the image center is overexposure, you can enable this function.

- **IR Light Mode**

IR light mode can be set to **Auto** and **Manual**.

- **Auto:** The brightness of the infrared light will be adjusted automatically. **IR Light Sensitivity** value ranges from 0 to 100. **Trigger Mode** can be set to **Camera** or **Photosensitive**.
- **Manual:** you need to adjust the brightness value of infrared light manually. **Brightness Limit** value ranges from 0 to 100.

Notes:

- The IR related functions are supported by the IR camera only.
- For detailed parameters configuration of IR light, you can enter the OSD menu by calling the special preset 95.
- When the **IR Light Mode** is auto, the day/night mode is adjusted automatically according to the IR Light Mode. Manually setting the day/night mode is invalid.
- When the **IR Light Mode** is manual and the **Brightness Limit** is 0, you can set the day/night mode manually.
- When the **IR Light Mode** is manual and the **Brightness Limit** is not 0, the night mode is set as the default mode. Manually setting the day/night mode is invalid.

Backlight Settings

- **BLC (Back Light Compensation)**

If there's a bright backlight, the subject in front of the backlight appears silhouetted or dark. Enabling **BLC** (back light compensation) function can correct the exposure of the subject. But the backlight environment is washed out to white.

- **WDR (Wide Dynamic Range)**

The wide dynamic range (WDR) function helps the camera provide clear images even under back light circumstances. When there are both very bright and very dark areas simultaneously in the field of view, WDR balances the brightness level of the whole image and provide clear images with details.

You can enable or disable the WDR function as shown in Figure 3-12. The wide dynamic level ranges from 0 to 100.



Figure 3-12 WDR

Note:

This function varies depending on different camera models.

- **HLC**

HLC (High Light Compensation) makes the camera identify and suppress the strong light sources that usually flare across a scene. This makes it possible to see the detail of the image that would normally be hidden.

White Balance

The **White Balance** mode can be set to **Auto**, **MWB**, **Outdoor**, **Indoor**, **Fluorescent Lamp**, **Sodium Lamp** and **Auto-Tracking**.

- **Auto**

In **Auto** mode, the camera retains color balance automatically according to the current color temperature.

- **MWB**

In **MWB** (Manual White Balance) mode, you can adjust the color temperature manually to meet your own demand as shown in Figure 3-13.

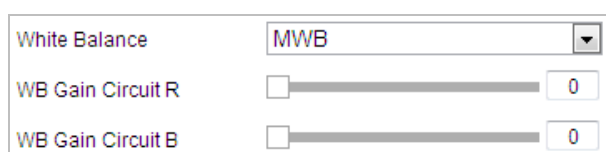

Figure 3-13 Manual White Balance

- **Outdoor**

You can select this mode when the camera is installed in outdoor environment.

- **Indoor**

You can select this mode when the camera is installed in indoor environment.

- **Fluorescent Lamp**

You can select this mode when there are fluorescent lamps installed near the camera.

- **Sodium Lamp**

You can select this mode when there are sodium lamps installed near the camera.

- **Auto-Tracking**

In **Auto-Tracking** mode, white balance is continuously being adjusted in real-time according to the color temperature of the scene illumination.

Image Enhancement

- **Digital Noise Reduction**

The digital noise reduce function processes the noise in the video signal.

You can set **Digital Noise Reduction** function to **Normal** and adjust the **Noise Reduction Level** as shown in Figure 3-14. The level ranges from 0 to 100.

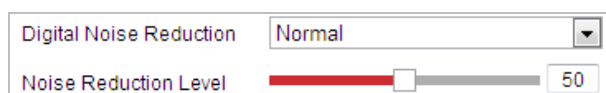

Figure 3-14 Normal Mode

If you are a professional technician, you can set it to Expert Mode then adjust Space DNR Level and Time DNR Level.

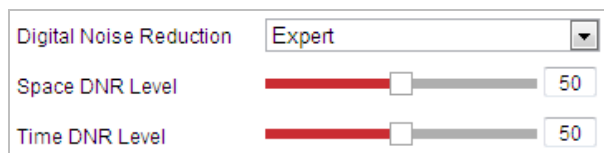

Figure 3-15 Expert Mode

- **Defog Mode**

When there is fog in the image, you can enable this function to get clear image.

- **EIS (Electronic Image Stabilization)**

The live view image would be trembled and dim when the camera is shocked slightly in some monitoring conditions. And the electronic image stabilization (EIS) function is used to overcome this problem to ensure a steady and clear image.

Video Adjustment

- **Mirror**

If you turn the **MIRROR** function on, the image will be flipped. It is like the image in the mirror. The flip direction can be set to OFF, or CENTER.

- **Video Standard**

You can set the **Video Standard** to 50 Hz (PAL) or 60 Hz (NTSC) according to the video system in your country.

- **Capture Mode:**

The **Capture Mode** can be selected from the list.

Other

- **Lens Initialization**

The lens operates the movements for initialization when you check the **Lens Initialization** checkbox.

- **Zoom Limit**

You can set **Zoom Limit** value to limit the maximum value of zooming. The value can be selected from the list.

Note:

Lens Initialization and **Zoom Limit** functions are supported by Camera 1 only.

- **Exposure Synchronization**

Select **ON** from the dropdown list to enable exposure synchronization function for Camera 2 or Camera 3.

3.3.2 Configuring OSD Settings

Purpose:

The camera supports following on screen displays:

Zoom: Identifies the amount of magnification.

Direction: Displays panning and tilting direction, with the format of PXXX TXXX. The XXX following P indicates the degrees in pan direction, while the XXX following T indicates the degrees in tilt position.

Time: Supports for time display.

Preset Title: Identifies preset being called.

Camera Name: Identifies the name of camera.

You can customize the on screen display of time.

Steps:

1. Enter the OSD settings interface:

Configuration > Image > OSD Settings

Figure 3-16 OSD Settings

2. Check the corresponding checkbox to select the display of camera name, date or week if required.
3. Edit the camera name in the text field of **Camera Name**.
4. Select from the dropdown list to set the time format, date format and display mode.
5. You can use the mouse to drag the text frame **IPdome** in the live view window to adjust the OSD position.



Figure 3-17 Adjust OSD Location

6. The font color can also be customized, select the Custom in the drop down list and select the font color on your demand.



7. Click  to activate above settings.

3.3.3 Configuring Text Overlay Settings

Purpose:

You can customize the text overlay.

Steps:

1. Enter the Text Overlay settings interface:
Configuration > Image > OSD Settings
2. Check the checkbox in front of textbox to enable the on-screen display.
3. Input the characters in the textbox.
4. Use the mouse to drag the red text frame  in the live view window to adjust the text overlay position.
5. Click .

Note:

There are up to 8 text overlays configurable.

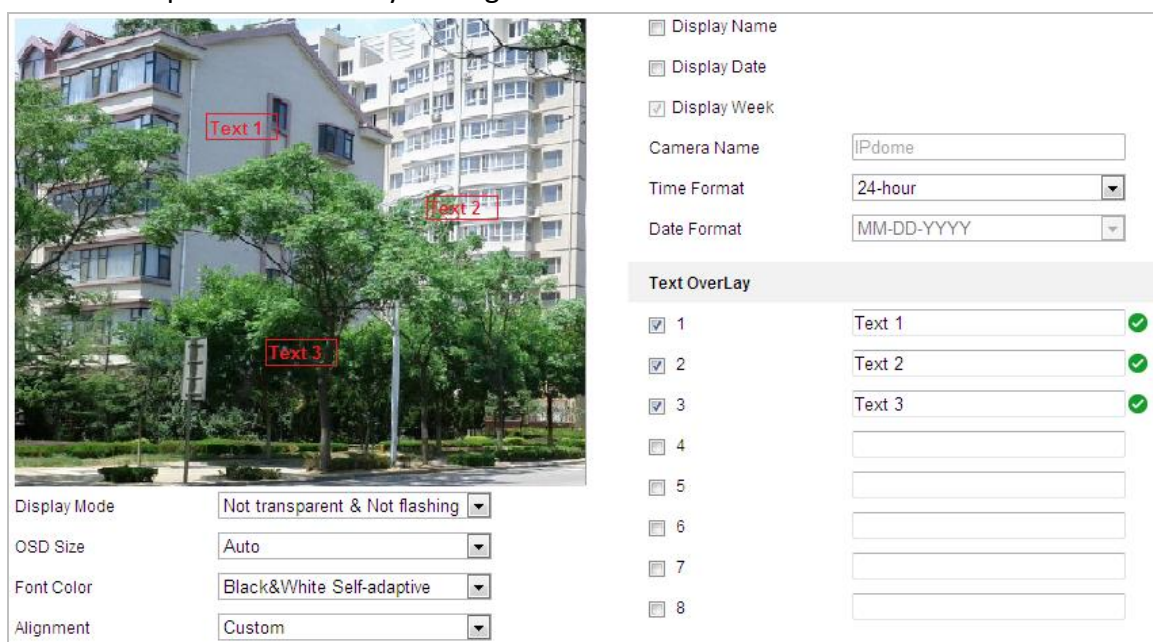

Figure 3-18 Text Overlay Settings

3.4 Configuring Video and Audio Settings

3.4.1 Configuring Video Settings

Steps:

1. Enter the Video settings interface:
Configuration > Video/Audio > Video

Channel No.	Camera 2
Stream Type	Main Stream(Normal)
Video Type	Video Stream
Resolution	4096*1200
Bitrate Type	Constant
Video Quality	Medium
Frame Rate	25 fps
Max. Bitrate	8192 Kbps
Video Encoding	H.264
Profile	High Profile
I Frame Interval	50
Smoothing	<input type="range" value="50"/> 50 [Clear<->Smooth]
Resolution Mode	20:6



Figure 3-19 Configure Video Settings

2. Select the **Stream Type** of the camera to Main Stream (Normal), Sub-Stream or Third Stream.

Note:

The main stream is usually for recording and live viewing with good bandwidth, and the sub-stream can be used for live viewing when the bandwidth is limited. Refer to the **Section 2.1 Configuring Local Parameters** for switching the stream type for live viewing.

3. You can customize the following parameters for the selected stream:

Video Type:

Select the stream type to video stream, or video & audio composite stream. The audio signal will be recorded only when the **Video Type** is **Video&Audio**.

Resolution:

Select the resolution of the video output.

Bitrate Type:

Select the bitrate type to constant or variable.

Video Quality:

When bitrate type is selected as **Variable**, 6 levels of video quality are selectable.

Frame Rate:

The frame rate is to describe the frequency at which the video stream is updated and it is measured by frames per second (fps). A higher frame rate is advantageous when there is movement in the video stream, as it maintains image quality throughout.

Max. Bitrate:

Set the max. bitrate. The higher value corresponds to the higher video quality, and the higher bandwidth is required as well.

Video Encoding:

Select the **Video Encoding** standard for the each camera.

Profile:

You can set the profile level to **High Profile**, **Main Profile** or **Basic Profile**.

I Frame Interval:

Set the I-Frame interval from 1 to 400.

SVC:

SVC is a video encoding technology. It extracts frames from the original video and sends these frames to a video recorder which also supports SVC function when the network bandwidth is insufficient.

Smoothing:

Drag  to adjust the value of video smoothing on your demand.

Resolution Mode:

Resolution of the panoramic view channels are different in different resolution mode (including main stream, sub-stream and third stream). Select the resolution mode from the dropdown list on your demand.

Notes:

- The function is only supported by Camera 2 and Camera 3.
- Reboot the device before it takes effect when the resolution mode is switched.
- Redraw the rule area if the resolution mode is switched.

4. Click  to save the settings.

3.4.2 Configuring Audio Settings

Steps:

1. Enter the Audio settings interface

Configuration > Video/Audio > Audio

2. Configure the following settings.

Audio Encoding: G.722.1, G.711ulaw, G.711alaw, MP2L2, PCM and G.726 selectable.

Audio Stream Bitrate: When the Audio Encoding is selected as MP2L2, you can configure the Audio Stream Bitrate in the dropdown list. The greater the value is, the better the audio quality will be.

Sampling Rate: When the Audio Encoding is selected as MP2L2 or PCM, you can configure the Sampling Rate in the dropdown list. The greater the value is, the better the audio quality will be.

Audio Input: When an intercom is connected to the camera, you need to set this option to **Lineln**. When a microphone is connected to the camera, you need to set this option to **Micln**.

Input Volume: Slid the bar to turn up/down the volume. The value ranges from 0 to 100.

Environmental Noise Filter: When the monitoring environment is very noisy, you can enable this function to reduce part of the noise.

3. Click  to save the settings.

3.4.3 Configuring ROI Settings

Before you start:

ROI (Region of Interest) encoding is used to enhance the quality of images which are specified in advance.

Enter the ROI settings interface:

Configuration > Video/Audio > ROI

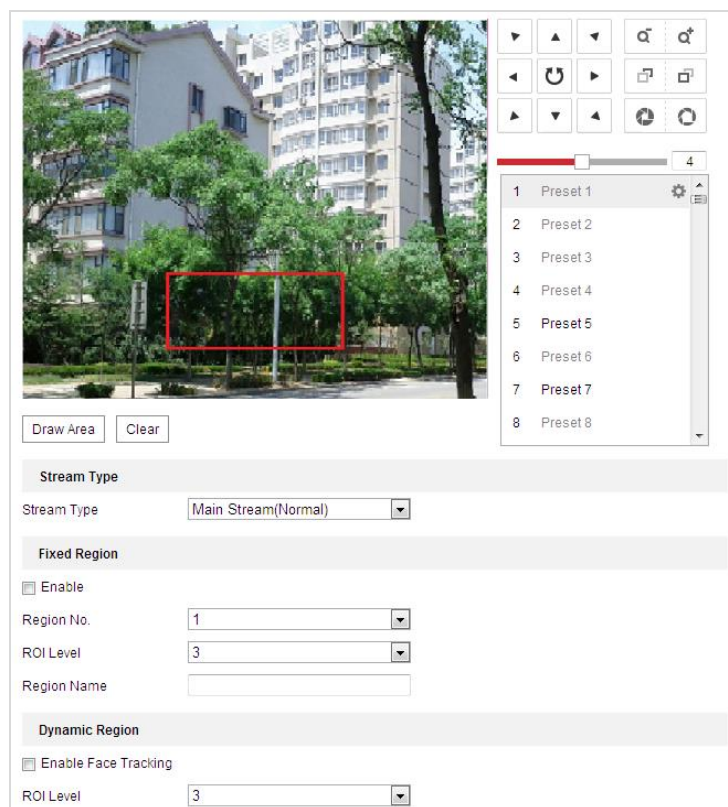

Figure 3-20 Region of Interest

Stream Type:

You can set the ROI function for main stream, sub-stream and third stream. Select a stream type and then configure the ROI settings.

- **Fixed Region:** The fixed region encoding is the ROI encoding for the manually configured area. And you can choose the Image Quality Enhancing level for ROI encoding, and you can also name the ROI area.

Steps:

1. Select a **Region No.**.
 2. Check the **Enable** checkbox under **Fixed Region**.
 3. Select the region from the dropdown list for ROI settings. There are four fixed regions selectable.
 4. Click , and then drag the mouse to draw the region of interest on the live video.
 5. Adjust the **ROI level** from 1 to 6. The higher the value, the better image quality in the red frame.
 6. Enter a **Region Name** and click **Save** to save the settings.
- **Dynamic Region:** The device can automatically calculate the region with motion. Set the Image Quality Enhancing level for ROI encoding.

Steps:

1. Check the **Face Tracking** checkbox.
When the face detection is triggered, the image quality of the face will be increased.
2. Respectively set the ROI level. The higher the value, the better image quality in the red frame.
3. Click **Save** to save the settings.

Chapter 4 PTZ Control

4.1 Operating PTZ Control

Purpose:

In the live view interface, you can use the PTZ control buttons to control panning, tilting and zooming. Refer to **Section 3.2.2 Live View Operation** for detailed information.

4.1.1 Setting/Calling a Preset

Purpose:

A preset is a predefined image position. For the defined preset, you can click the calling button to quickly view the desired image position.

● **Setting a Preset:**

Steps:

1. In the PTZ control panel, select a preset number from the preset list.

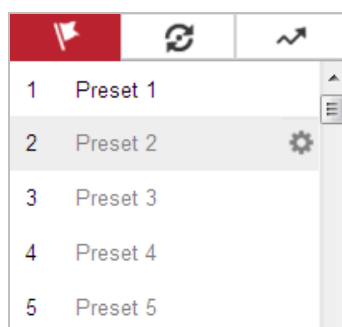



Figure 4-1 Setting a Preset

2. Use the PTZ control buttons to move the lens to the desired position.
 - Pan the camera to the right or left.
 - Tilt the camera up or down.
 - Zoom in or out.
 - Refocus the lens.
3. Click  to finish the setting of the current preset.
4. Edit a preset name by double clicking on the default name such as preset 1. (The pre-defined presets are named already and not configurable. Refer to the user manual for detailed function description.)
5. You can click  to delete the preset.

Note:

You can configure up to 300 presets.

● **Calling a Preset:**

In the PTZ control panel, select a defined preset from the list and click  to call the preset.

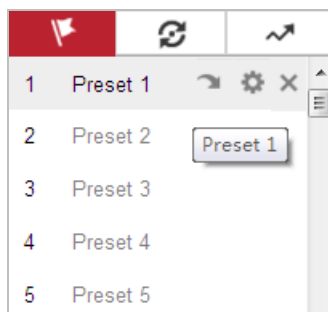

Figure 4-2 Calling a Preset

For convenient preset selection, refer to the following steps to navigate to the preset you want.

Steps:

1. Select any preset from the list.
2. Click the preset number you need on the keyboard.

Note:

The following presets are predefined with special commands. You can only call them but not configure them. For instance, preset 99 is the “Start auto scan”. If you call the preset 99, the camera starts auto scan function.

Table 4-1 Special Presets

Presets	Function	Presets	Function
33	Auto flip	92	Start to set limit stops
34	Back to initial position	93	Set limit stops manually
35	Call patrol 1	94	Remote reboot
36	Call patrol 2	95	Call OSD menu
37	Call patrol 3	96	Stop a scan
38	Call patrol 4	97	Start random scan
39	Day mode (IR cut filter in)	98	Start frame scan
40	Night mode (IR cut filter out)	99	Start auto scan
41	Call pattern 1	100	Start tilt scan
42	Call pattern 2	101	Start panorama scan
43	Call pattern 3	102	Call patrol 5
44	Call pattern 4	103	Call patrol 6
45	One-touch patrol	104	Call patrol 7
90	Wiper	105	Call patrol 8

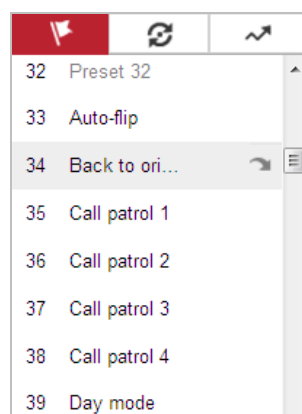

Figure 4-3 Special Preset

Note:

You may need to use the OSD (On Screen Display) menu when controlling the camera remotely. To display the OSD menu on the live view screen, you can call the preset number 95.

4.1.2 Setting/Calling a Patrol

Purpose:



A patrol is a memorized series of preset function. It can be configured and called on the patrol settings interface. There are up to 8 patrols for customizing. A patrol can be configured with 32 presets.

Before you start:

Make sure that the presets you want to add into a patrol have been defined.

- **Setting a Patrol:**

Steps:

1. In the PTZ control panel, click  to enter the patrol settings interface.
2. Select a patrol number from the list and click .
3. Click  to enter the adding interface of preset, as shown in Figure 4-4.

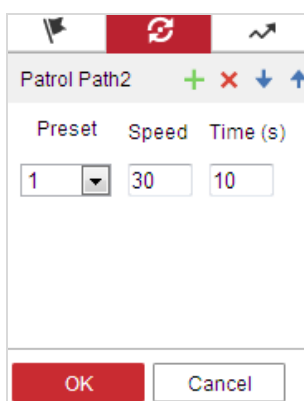

Figure 4-4 Adding Presets

4. Configure the preset number, patrol time and patrol speed.

Table 4-2 Patrol Time and Patrol Speed

Name	Description
Patrol Time	It is the duration staying on one patrol point. The camera moves to another patrol point after the patrol time.
Patrol Speed	It is the speed of moving from one preset to another.

5. Click **OK** to save a preset into the patrol.
6. Repeat the steps from 3 to 5 to add more presets.
7. Click **OK** to save all the patrol settings.

- **Calling a Patrol:**

In the PTZ control panel, select a defined patrol from the list and click  to call the patrol, as shown in Figure 4-5.

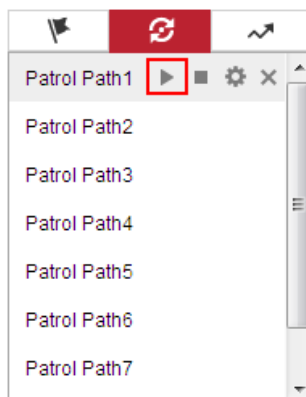

Figure 4-5 Calling a Patrol

4.1.3 Setting/Calling a Pattern

Purpose:

A pattern is a memorized series of pan, tilt, zoom, and preset functions. It can be called on the pattern settings interface. There are up to 4 patterns for customizing.

● **Setting a Pattern:**

Steps:

1. In the PTZ control panel, click  to enter the pattern settings interface.
2. Select a pattern number from the list as shown in Figure 4-6.

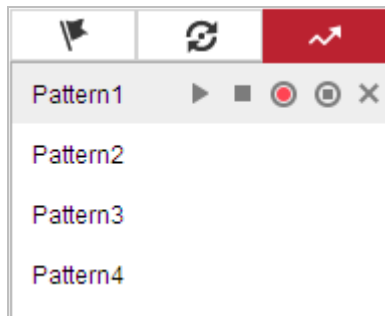



Figure 4-6 Patterns Settings Interface

3. Click  to enable recording the panning, tilting and zooming actions.
4. Use the PTZ control buttons to move the lens to the desired position after the information of **Program Pattern Remaining Memory (%)** is displayed on the screen.
 - Pan the camera to the right or left.
 - Tilt the camera up or down.
 - Zoom in or out.
 - Refocus the lens.
5. Click  to save all the pattern settings.

Notes:

- These 4 patterns can be operated separately and with no priority level.
- When configuring and calling the pattern, proportional pan is valid; the limit stops and auto flip will be invalid; and the 3D positioning operation is not supported.

4.2 PTZ Configuration

4.2.1 Configuring Basic PTZ Parameters

Purpose:

You can configure the basic PTZ parameters, including proportional pan, preset freezing, preset speed, etc.

1. Enter the Basic PTZ parameter configuration interface:

Configuration > PTZ > Basic Settings

Basic Parameter	
<input checked="" type="checkbox"/> Enable Proportional Pan	
<input type="checkbox"/> Enable Preset Freezing	
Preset Speed	4
Manual Control Speed	Compatible
Keyboard Control Speed	Medium
Auto Scan Speed	28
Zooming Speed	3

PTZ OSD	
Zoom Status	2s
PT Status	2s
Preset Status	2s

Power Off Memory	
Set Resume Time Point	30s

Save

Figure 4-7 Basic PTZ Configuration Interface

2. Configure the following settings:

- ◆ **Basic Parameters:** Enable/disable proportional pan and preset freezing, set the preset speed, manual control speed, keyboard control speed, auto scan speed, and zooming speed.
 - **Proportional Pan:** If you enable this function, the pan/tilt speeds change according to the amount of zoom. When there is a large amount of zoom, the pan/tilt speed will be slower for keeping the image from moving too fast on the live view image.
 - **Preset Freezing:** This function enables the live view to switch directly from one scene defined by a preset to another, without showing the middle areas between these two, to ensure the surveillance efficiency. It can also reduce the use of bandwidth in a digital network system.

Note:

Preset freezing function is invalid when you calling a pattern.

- **Preset Speed:** You can set the speed of a defined preset from 1 to 8.
- **Manual Control Speed:** The manual control speed can be set as Compatible, Pedestrian, Non-motor Vehicle, Motor Vehicle or Auto.

- **Compatible:** The control speed is same as the Keyboard Control Speed.
 - **Pedestrian:** Choose the **Pedestrian** when you monitor the pedestrians.
 - **Non-motor Vehicle:** Choose the **Non-motor Vehicle** when you monitor the non-motor vehicles.
 - **Motor Vehicle:** Choose the **Motor Vehicle** when you monitor the motor vehicles.
 - **Auto:** You are recommended to set it to be auto when the application scene of the camera is complicated.
 - **Keyboard Control Speed:** Define the speed of PTZ control by a keyboard as Low, Medium or High.
 - **Auto Scan Speed:** The scan speed can be set from level 1 to 40.
 - **Zooming Speed:** The zoom speed is adjustable from level 1 to 3.
 - ◆ **PTZ OSD:** Set the on-screen display duration of the PTZ status.
 - **Zoom Status:** Set the OSD duration of zooming status as 2 seconds, 5 seconds, 10 seconds, Always Close or Always Open.
 - **PT Status:** Set the azimuth angle display duration while panning and tilting as 2 seconds, 5 seconds, 10 seconds, Always Close or Always Open.
 - **Preset Status:** Set the preset name display duration while calling the preset as 2 seconds, 5 seconds, 10 seconds, Always Close or Always Open.
 - ◆ **Power-off Memory:** The camera can resume its previous PTZ status or actions after it restarted from a power-off. You can set the time point of which the camera resumes its PTZ status. You can set it to resume the status of 30 seconds, 60 seconds, 300 seconds or 600 seconds before power-off.
3. Click  to save the settings.

4.2.2 Configuring PTZ Limits

Purpose:

The camera can be programmed to move within the configurable PTZ limits (left/right, up/down).

Steps:

1. Enter the Limit configuration interface:
Configuration > PTZ > Limit

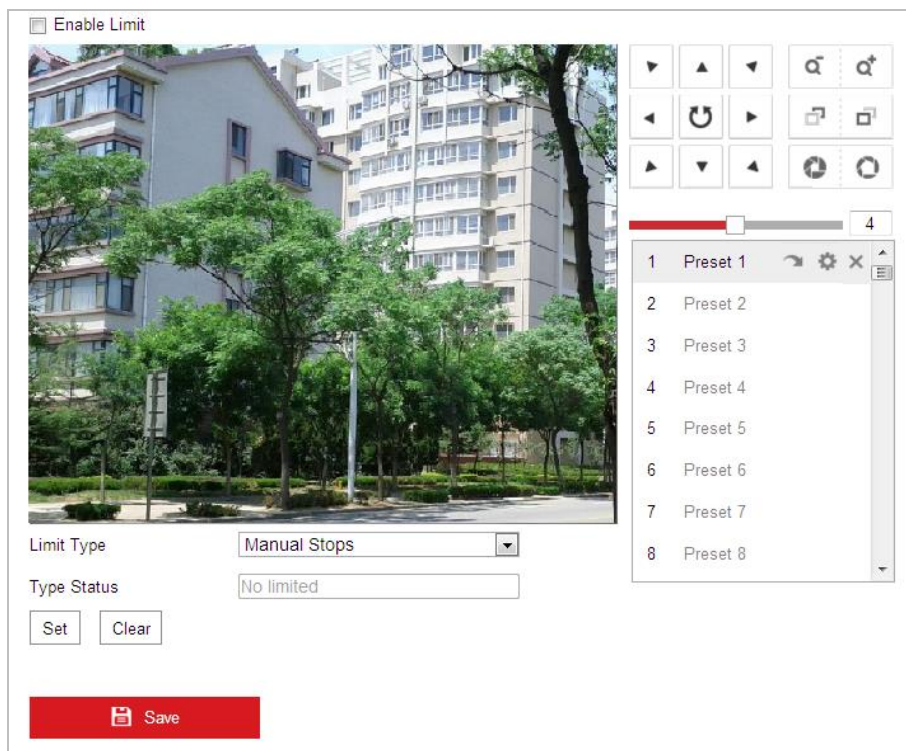

Figure 4-8 Configure the PTZ Limit

2. Click the **Enable Limit** checkbox and choose the limit type as manual stops or scan stops.
 - **Manual Stops:**
When manual limit stops are set, you can operate the PTZ control panel manually only in the limited surveillance area.
 - **Scan Stops:**
When scan limit stops are set, the random scan, frame scan, auto scan, tilt scan, panorama scan is performed only in the limited surveillance area.

Note:
Manual Stops of **Limit Type** is prior to **Scan Stops**. When you set these two limit types at the same time, **Manual Stops** is valid and **Scan Stops** is invalid.
3. Click the PTZ control buttons to find the left/right/up/down limit stops; you can also call the defined presets and set them as the limits of the camera.
4. Click **Set** to save the limits or click **Clear** to clear the limits.

4.2.3 Configuring Initial Position

Purpose:

The initial position is the origin of PTZ coordinates. It can be the factory default initial position. You can also customize the initial position according to your own demand.

◆ **Customize an Initial Position:**

Steps:

1. Enter the Initial Position configuration interface:
Configuration > PTZ > Initial Position

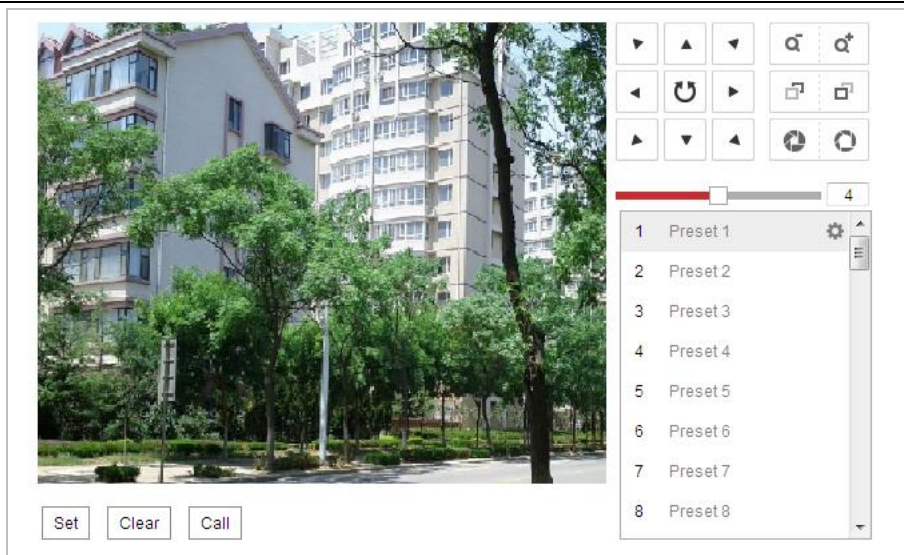



Figure 4-9 PTZ Configuration

2. Click the PTZ control buttons to find a position as the initial position of the camera; you can also call a defined preset and set it as the initial position of the camera.
3. Click **Set** to save the position.

◆ **Call/delete an Initial Position:**

You can click  to call the initial position. You can click  to delete the initial position and restore the factory default initial position.

4.2.4 Configuring Park Action

Purpose:

This feature allows the camera to start a predefined park action (scan, preset, pattern and etc.) automatically after a period of inactivity (park time). The park action function only takes effect in Camera 1.

Note:

Scheduled Tasks function is prior to **Park Action** function. When these two functions are set at the same time, only the **Scheduled Tasks** function takes effect.

Steps:

1. Enter the Park Action settings interface:

Configuration > PTZ > Park Action

Figure 4-10 Set the Park Action

2. Check the **Enable Park Action** checkbox.
3. Set the **Park Time** as the inactivity time of the camera before it starts the park actions.
4. Choose **Action Type** from the dropdown list.

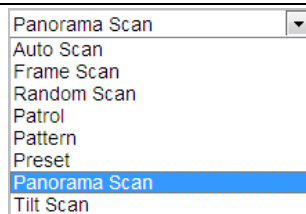

Figure 4-11 Action Types

5. Click  to save the settings.

4.2.5 Configuring Privacy Mask

Purpose:

Privacy mask enables you to cover certain areas on the live video to prevent certain spots in the surveillance area from being live viewed and recorded. The privacy mask function only takes effect in Camera 1.

Steps:

1. Enter the Privacy Mask settings interface:

Configuration > PTZ > Privacy Mask

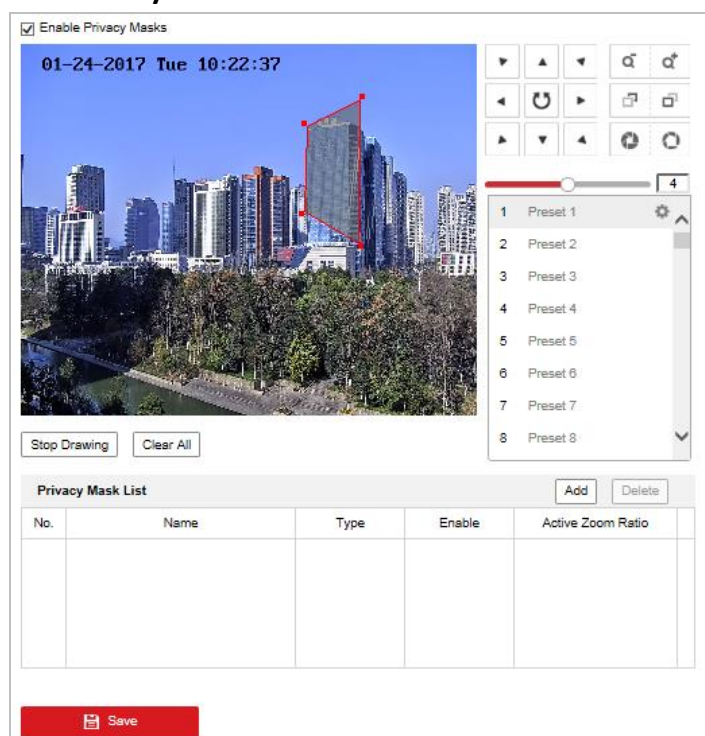

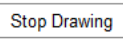



Figure 4-12 Draw the Privacy Mask

2. Click the PTZ control buttons to find the area you want to set the privacy mask.
3. Click ; drag the mouse in the live video window to draw the area. You can drag the corners of the red rectangle area to draw a polygon mask.
4. Click  to finish drawing or click  to clear all of the areas you set without saving them.

5. Click to save the privacy mask, and it will be listed in the **Privacy Mask List** area; set the value of **Active Zoom Ratio** on your demand, and then the mask will only appear when the zoom ratio is greater than the predefined value.

Privacy Mask List					<input type="button" value="Add"/>	<input type="button" value="Delete"/>
No.	Name	Type	Enable	Active Zoom Ratio		
1	Privacy Mask 1	gray	Yes	1		

Figure 4-13 Privacy Mask List

6. you can also define the color of the masks.

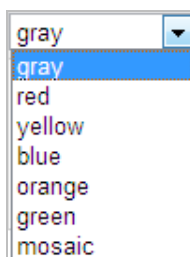

Figure 4-14 Define Mask Color

7. You can select a mask and click to delete it from the list.
8. Check the **Enable Privacy Mask** checkbox to enable this function.

Note:

You are allowed to draw up to 24 areas on the same image.

4.2.6 Configuring Scheduled Tasks

Purpose:

You can configure the network camera to perform a certain action automatically in a user-defined time period.

Steps:

1. Enter the Scheduled Task settings interface:

Configuration > PTZ > Scheduled Tasks

Figure 4-15 Configure Scheduled Tasks

2. Check the **Enable Scheduled Task** checkbox.
3. Set the **Park Time**. You can set the park time (a period of inactivity) before the camera starts the scheduled tasks.
4. Select the task type from the dropdown list. You can choose scan, preset, pattern and etc.

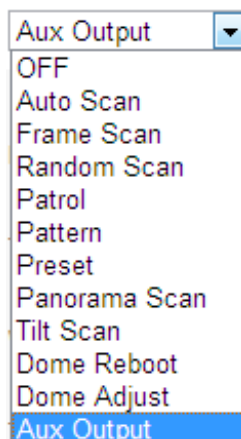

Figure 4-16 Task Types

5. Select the timeline of a certain day, and drag the left button of the mouse to set the recording schedule (the start time and end time of the recording task).
6. After you set the scheduled task, you can click  and copy the task to other days (optional).

Figure 4-17 Edit the Schedule and Task Type

- After setting the record schedule, you can click a record segment to display the segment record settings interface to edit the segment record parameters. (Optional)

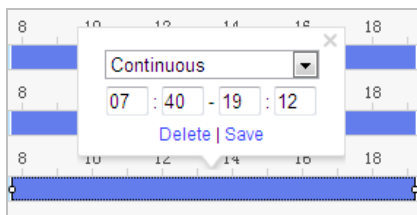

Figure 4-18 Segment Record Settings

Note:

The time of each task cannot be overlapped. Up to 10 tasks can be configured for each day.

- Click  to save the settings.

4.2.7 Clearing PTZ Configurations

Purpose:

You can clear PTZ configurations in this interface, including all presets, patrols, patterns, privacy masks, PTZ limits, scheduled tasks and park actions.

Steps:

- Enter the Clearing Configuration interface:
Configuration > PTZ > Clear Config
- Check the checkbox of the items you want to clear.
- Click  to clear the settings.

4.2.8 Configuring PTZ Control Priority

Steps:

- Get to the configuration interface:
Configuration > PTZ > Prioritize PTZ.
 - The camera can be controlled by network and RS-485 signals. You can set the control priority of these two signals.
 - The operation of **Operator** is prior to that of **User**. When the **Operator** is controlling the camera, the **User** cannot control it. When the **Operator** finishes, the **User** can control the camera after the **Delay** time. The **Delay** time can be set in Priority PTZ interface as shown follows.



Figure 4-19 PTZ Priority

- Click  to activate the settings.

4.2.9 Configuring Panorama Tracking

Purpose:

The camera tracks the moving objects automatically after you configure this function. It keeps the target appear in the center of the image by automatically adjusting its focal length and position.

You can click  in the live view interface to manually track the target.

Steps:

1. Enter the Panorama Tracking settings interface:

Configuration > PTZ > Panorama Tracking

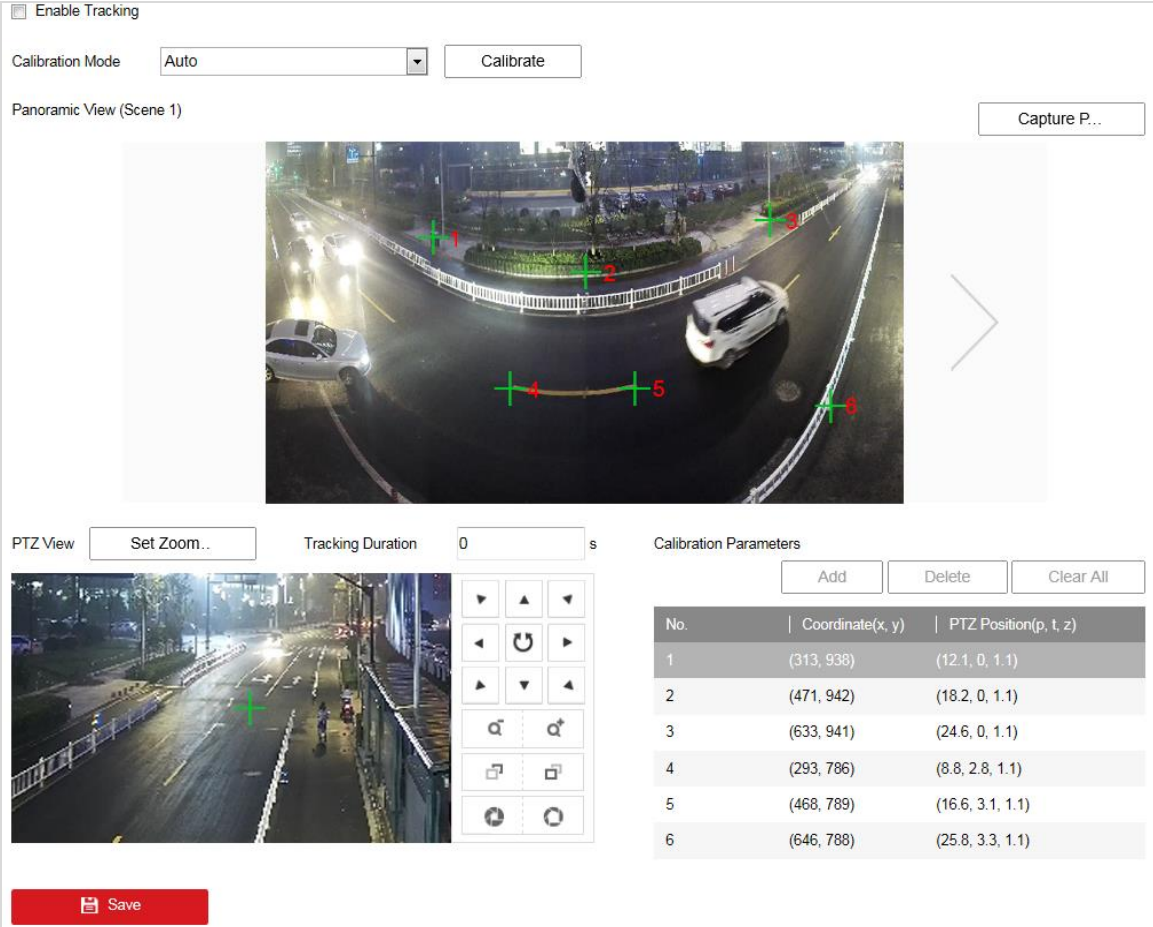

Enable Tracking

Calibration Mode: Auto

Panoramic View (Scene 1)

PTZ View Tracking Duration: 0 s

Calibration Parameters

No.	Coordinate(x, y)	PTZ Position(p, t, z)
1	(313, 938)	(12.1, 0, 1.1)
2	(471, 942)	(18.2, 0, 1.1)
3	(633, 941)	(24.6, 0, 1.1)
4	(293, 786)	(8.8, 2.8, 1.1)
5	(468, 789)	(16.6, 3.1, 1.1)
6	(646, 788)	(25.8, 3.3, 1.1)

Figure 4-20 Configure Smart Tracking



2. Check the **Enable Tracking** checkbox to enable panorama tracking function.
3. Perform the calibration.

Auto Calibration:

- (1) Select **Auto** from the calibration mode.
- (2) Move and zoom in/out the PTZ view to make sure the PTZ view and the panoramic view is almost the same.
- (3) Click **Save** to save the calibration settings.
- (4) The calibration is completed when note shows up as: **Calibration Succeeded.**

Manual Calibration:

- (1) Select **Manual Calibrating** from the calibration list.
- (2) Drag the crosses of the panoramic view “+” and move them to the scene evenly.

- (3) Select a calibration site and adjust the PTZ view by controlling PTZ and zooming in/ out to ensure the cross in the center of the PTZ view is almost the same with the site of the calibration site of panoramic view.
 - (4) Click  to save the setting of calibration No. 1.
 - (5) Select calibration site No. 2 to No. 6, and repeat the step above to add the manual calibration sites.
 - (6) Click **Calibrate** to perform the calibration, and click  to switch the scene and add calibration sites. In manual calibration mode, for each device, you shall add at least 4 calibration sites.
4. Set the tracking duration. The camera stops tracking when the duration time is up. The duration ranges from 0 to 60 seconds.
 5. Click to set the current zoom ratio as the tracking zoom ratio.
 6. You can select **Add**, **Delete**, and **Clear All** to edit the calibration sites. The coordinates and PTZ positions of selected calibration sites will appear in the list below. In auto calibration mode, click **Calibration** to refresh the PTZ position; and in manual calibration mode, click  to refresh the PTZ position.

Calibration Parameters		
<input type="button" value="Add"/> <input type="button" value="Delete"/> <input type="button" value="Clear All"/>		
No.	Coordinate(x, y)	PTZ Position(p, t, z)
1	(313, 938)	(12.1, 0, 1.1)
2	(471, 942)	(18.2, 0, 1.1)
3	(633, 941)	(24.6, 0, 1.1)
4	(293, 786)	(8.8, 2.8, 1.1)
5	(468, 789)	(16.6, 3.1, 1.1)
6	(646, 788)	(25.8, 3.3, 1.1)

Figure 4-21 Calibration Parameters

Notes:

- In auto calibration mode, the more similar is the PTZ view and the panoramic view, the panorama tracking gets more accurate.
- The more distant manual calibration sites are to each other, the panorama tracking gets more accurate.

4.2.10 Configuring Eagle Vision Focus

Purpose:

After this function is enabled, perform calibration and the focus can be quicker than quick focus.

Steps:

1. Enter the Eagle Vision Focus settings interface:

Configuration > PTZ > Eagle Vision Focus

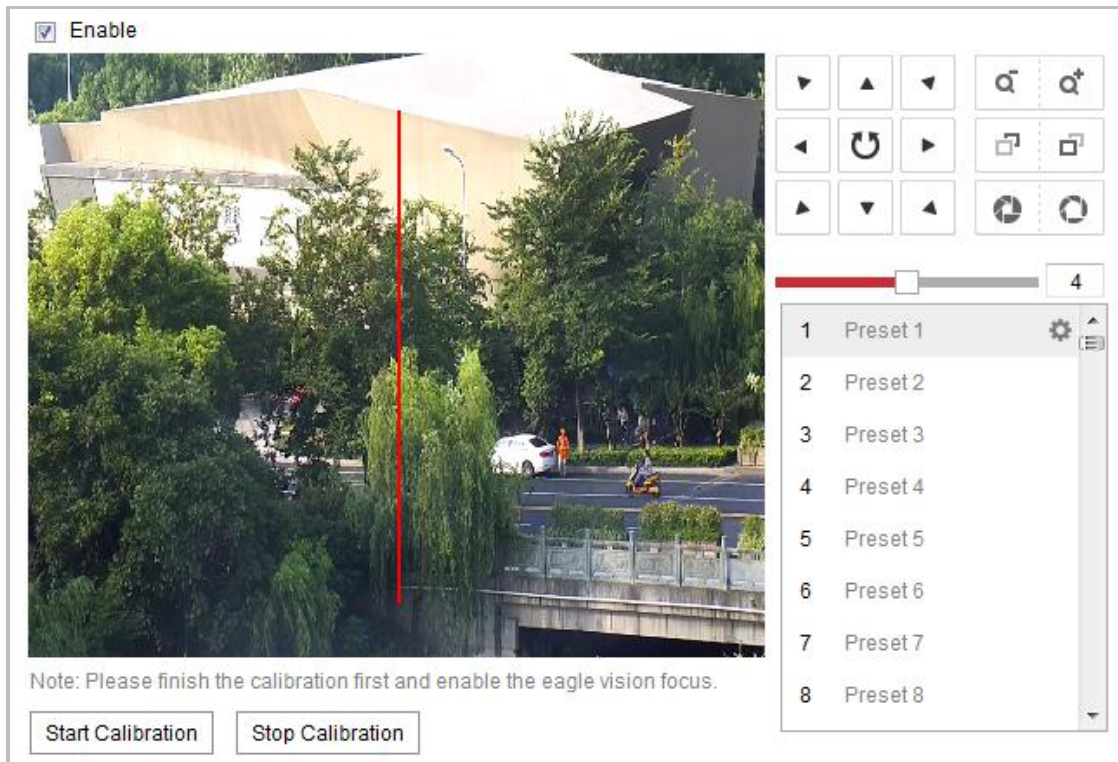

Figure 4-22 Eagle Vision Focus

2. Check the **Enable** checkbox to enable the Eagle Vision Focus function.
3. Drag the red line on the live view image to the calibration position. You can drag the ends of the red line to adjust the length of the line.
4. Click **Start Calibration**. There is the notice *Calibrating* on the live view image and the camera lens performs auto focus.
5. After calibration, there is the notice *Calibration succeeded* on the live view image.
6. Click **Save** to save the settings.

Chapter 5 Storage and Playback

In this and the following chapters, operation of the camera by the web browser will be taken as an example.

5.1 Storage Settings

Before you start:

To configure record settings, make sure that you have the network storage device within the network or the memory card has been inserted in the corresponding card slot. Refer to the quick start guide for the location of the memory card slot.

5.1.1 Configuring Net HDD (Optional)

Before you start:

The network disk should be available within the network and properly configured to store the recorded files, log files, etc.

Steps:

Add Net HDD

1. Enter the NAS (Network-Attached Storage) settings interface:

Configuration > Storage > Storage Management > Net HDD

HDD Management				
Net HDD				
HDD No.	Server Address	File Path	Type	Delete
1	10.10.36.61	/cxy_1	NAS	✘
Mounting Type: <input type="text" value="SMB/CIFS"/> User Name: <input type="text" value="cxy1"/> Password: <input type="password" value="•••••"/> <input type="button" value="Test"/>				
2	10.10.36.252	/dvr/yanjian_1	NAS	✘
3			NAS	✘

Figure 5-1 Select Net HDD Type

2. Enter the IP address and the file path of the network disk.
3. Select the mounting type. NFS and SMB/CIFS are selectable. You can set the user name and password to guarantee the security if SMB/CIFS is selected.

Note:

Refer to the *NAS User Manual* for creating the file path.



- For your privacy and to better protect your system against security risks, we strongly recommend the use of strong passwords for all functions and network devices. The password should be something of your own choosing (Using a minimum of 8 characters, including at least three of the following categories: upper case letters, lower case letters, numbers, and special characters.) in order to increase the security of your product.
- Proper configuration of all passwords and other security settings is the responsibility of the installer and/or end-user.

4. Click  to save the settings.

5.1.2 HDD Management

If the memory card is inserted in the device or NAS (Network-Attached Storage) is added, enter HDD Management interface to configure the storage status.

Steps:

1. Enter the HDD settings interface

Configuration > Storage > Storage Management > HDD Management,

You can view the capacity, free space, status, type and property of the disk.

The screenshot shows the 'HDD Management' interface. At the top, there are tabs for 'HDD Management' and 'Net HDD'. Below the tabs is a table with columns: HDD No., Capacity, Free space, Status, Type, Property, and Progress. There are two rows of data, both with checkboxes in the first column. Below the table is a 'Quota' section with four input fields: Max. Picture Capacity (4.50GB), Free Size for Picture (0.00GB), Max. Record Capacity (14.25GB), and Free Size for Record (6.75GB). A 'Format' button is located at the top right of the table area.

<input checked="" type="checkbox"/>	HDD No.	Capacity	Free space	Status	Type	Property	Progress
<input checked="" type="checkbox"/>	9	9.84GB	0.00GB	Normal	NAS	R/W	
<input checked="" type="checkbox"/>	10	10.00GB	6.75GB	Normal	NAS	R/W	

Quota

Max. Picture Capacity: 4.50GB

Free Size for Picture: 0.00GB

Max. Record Capacity: 14.25GB

Free Size for Record: 6.75GB

Figure 5-2 Storage Management Interface

2. If the status of the disk is **Uninitialized**, check the corresponding checkbox to select the disk and click **Format** to start initializing the disk.

When the initialization completed, the status of disk will become **Normal**.

The screenshot shows the 'HDD Management' interface. At the top, there are tabs for 'HDD Management', 'Set', and 'Format'. Below the tabs is a table with columns: HDD No., Capacity, Free space, Status, Type, Property, and Progress. There is one row of data with a checkbox in the first column. The status of the disk is 'Formatting'.

<input checked="" type="checkbox"/>	HDD No.	Capacity	Free space	Status	Type	Property	Progress
<input checked="" type="checkbox"/>	9	20.00GB	0.00GB	Formatting	NAS	R/W	

Figure 5-3 View Disk Status

Define the Quota for Record and Pictures

Steps:

1. Input the quota percentage for picture and for record.
2. Click **Save** and refresh the browser page to activate the settings.

The screenshot shows the 'Quota' settings interface. It has six input fields: Max. Picture Capacity (4.75GB), Free Size for Picture (4.75GB), Max. Record Capacity (14.50GB), Free Size for Record (14.50GB), Percentage of Picture (25%), and Percentage of Record (75%). A red 'Save' button is at the bottom.

Quota

Max. Picture Capacity: 4.75GB

Free Size for Picture: 4.75GB

Max. Record Capacity: 14.50GB

Free Size for Record: 14.50GB

Percentage of Picture: 25%

Percentage of Record: 75%

Save

Figure 5-4 Quota Settings

Note:

Up to 8 NAS disks can be connected to the camera.

5.1.3 Configuring Record Schedule

Before you start:

Make sure a local memory card is inserted in the camera or the network storage is added to the camera.

Purpose:

There are two kinds of recording for the cameras: manual recording and scheduled recording. In this section, you can follow the instructions to configure the scheduled recording. By default, the record files of scheduled recording are stored in the memory card (if supported) or in the network disk.

Steps:

1. Enter the Record Schedule settings interface:

Configuration > Storage > Schedule Settings > Record Schedule

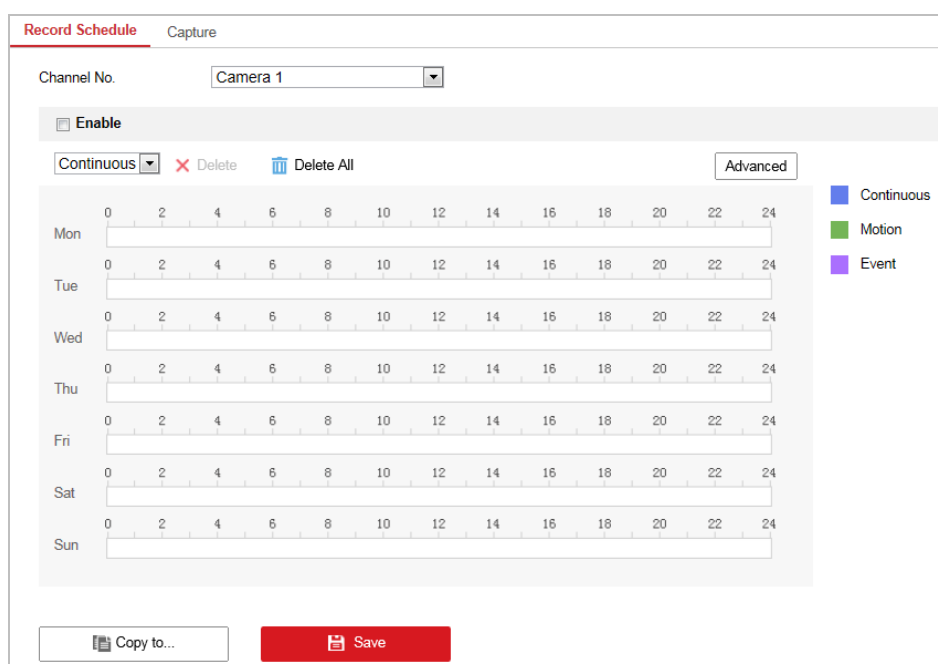

Figure 5-5 Record Schedule Interface

2. Check the **Enable** checkbox to enable scheduled recording.
3. To set the advanced settings of the camera, click **Advanced** to enter the advanced settings interface.

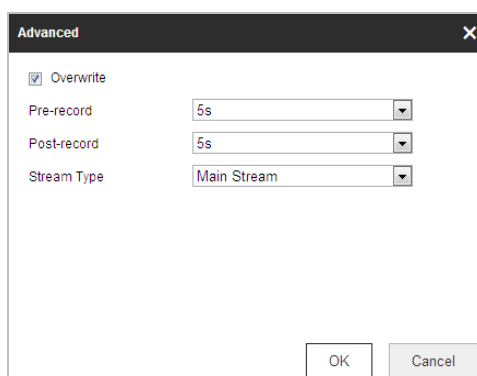

Figure 5-6 Record Parameters

- **Pre-record:** The time you set to start recording before the scheduled time or the event. For example, if an alarm triggers recording at 10:00, and the pre-record time is set as 5 seconds, the camera starts to record at 9:59:55.

The Pre-record time can be configured as No Pre-record, 5 s, 10 s, 15 s, 20 s, 25 s, 30 s or not limited.

Note:

The pre-record time changes according to the video bitrate.

- **Post-record:** The time you set to stop recording after the scheduled time or the event. For example, if an alarm triggered recording ends at 11:00, and the post-record time is set as 5 seconds, the camera records until 11:00:05.

The Post-record time can be configured as 5 s, 10 s, 30 s, 1 min, 2 min, 5 min or 10 min.

Note:

The Pre-record and Post-record parameters vary depending on different camera models.

- **Stream Type:** You can select the stream type for recording; Main stream, sub stream and third stream are selectable. If you select the sub stream, you can record for a longer time with the same storage capacity.

4. Click **OK** to save the advanced setting.



Figure 5-7 Record Schedule

5. Set the record schedule:

- (1) Select a **Record Type**. The record type can be Continuous, Motion, Alarm, Motion | Alarm, Motion & Alarm, and Events.

- **Continuous**

If you select **Continuous**, the video will be recorded automatically according to the time of the schedule.

- **Record Triggered by Motion Detection**

If you select **Motion**, the video will be recorded when the motion is detected.

Besides configuring the recording schedule, you have to set the motion detection area and check the **Trigger Channel** checkbox in the **Linkage Method** of Motion Detection settings interface. For detailed information, refer to the *Step 1 in the Section 6.1.1 Configuring Motion Detection*.

- **Record Triggered by Alarm**

If you select **Alarm**, the video will be recorded when the alarm is triggered via the external alarm input channels.

Besides configuring the recording schedule, you have to set the **Alarm Type** and check the **Trigger Channel** checkbox in the **Linkage Method** of **Alarm Input Settings** interface. For detailed information, refer to **Section 6.1.4 Configuring Alarm Input**.

- **Record Triggered by Motion | Alarm**

If you select **Motion | Alarm**, the video will be recorded when the external alarm is triggered or the motion is detected.

Besides configuring the recording schedule, you have to configure the settings on the **Motion Detection** and **Alarm Input** settings interfaces. Refer to **Section 6.1.1** and **Section 6.1.4** for detailed information.

- **Record Triggered by Motion & Alarm**

If you select **Motion & Alarm**, the video will be recorded when the motion and alarm are triggered at the same time.

Besides configuring the recording schedule, you have to configure the settings on the **Motion Detection** and **Alarm Input** settings interfaces. Refer to **Section 6.1.1** and **Section 6.1.4** for detailed information.

- **Record Triggered by Events**

If you select **Events**, the video will be recorded when any event is detected.

- (2) Select the timeline of a certain day, and drag the left button of the mouse to set the recording schedule (the start time and end time of the recording task).
- (3) After you set the scheduled task, you can click  and copy the task to other days (optional).
- (4) After setting the record schedule, you can click a record segment to display the segment record settings interface to edit the segment record parameters. (optional)

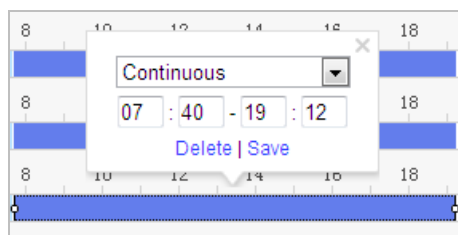



Figure 5-8 Segment Record Settings

Note:

The time of each segment cannot be overlapped. Up to 8 segments can be configured for each day.

6. Click  to copy the schedule settings to other channels if the schedule settings are the same.
7. Click  to save the settings.

5.1.4 Configuring Capture Schedule

Purpose:

You can configure the scheduled snapshot and event-triggered snapshot. The captured picture can be stored in the local storage or network storage.

Steps:

1. Enter the Capture settings interface:

Configuration > Storage > Storage Settings > Capture

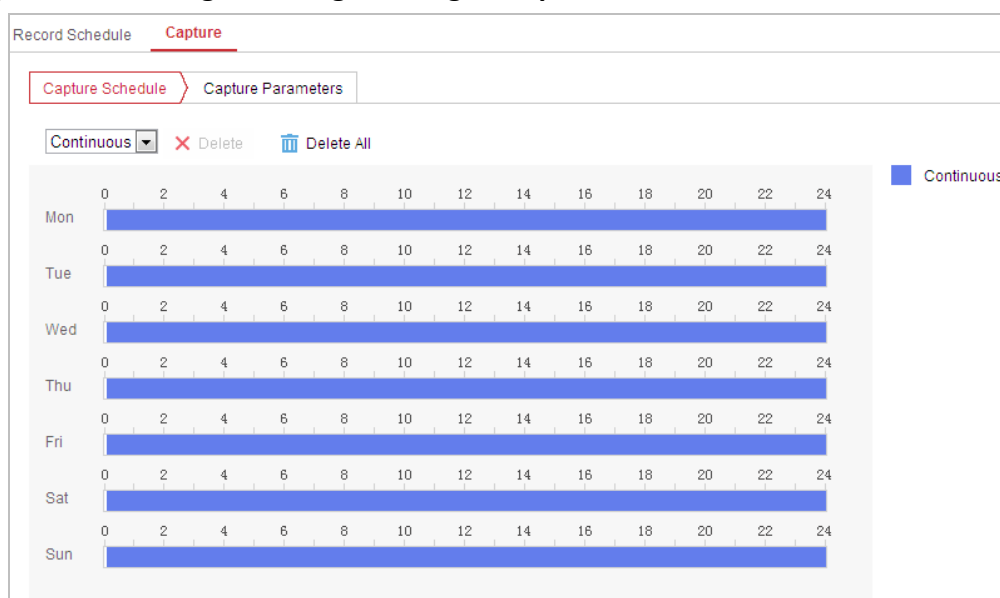



Figure 5-9 Snapshot Settings

2. Click Capture Schedule to enter the Capture interface.
3. Select the timeline of a certain day, and drag the left button of the mouse to set the capture schedule (the start time and end time of the recording task).
4. After you set the scheduled task, you can click  and copy the task to other days (optional).
5. After setting the capture schedule, you can click a capture segment to display the segment capture settings interface to edit the segment capture parameters. (optional)

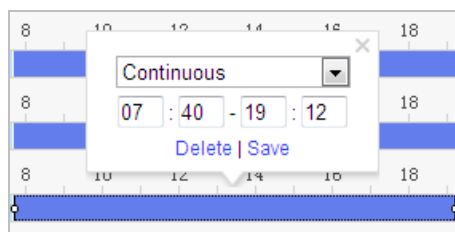

Figure 5-10 Segment Snapshot Settings

6. Click Capture Parameters to enter the Capture Parameters interface.
7. Check the **Enable Timing Snapshot** checkbox to enable continuous snapshot, and configure the schedule of timing snapshot. Check the **Enable Event-triggered Snapshot** checkbox to enable event-triggered snapshot.
8. Select the format, resolution, quality of the snapshot.
9. Set the time interval between two snapshots.
10. Click Save to save the settings.

5.2 Picture

Purpose:

This section explains how to view the captured picture files stored in the network disks and download the captured pictures.

Steps:

1. Click **Picture** on the menu bar to enter picture interface.

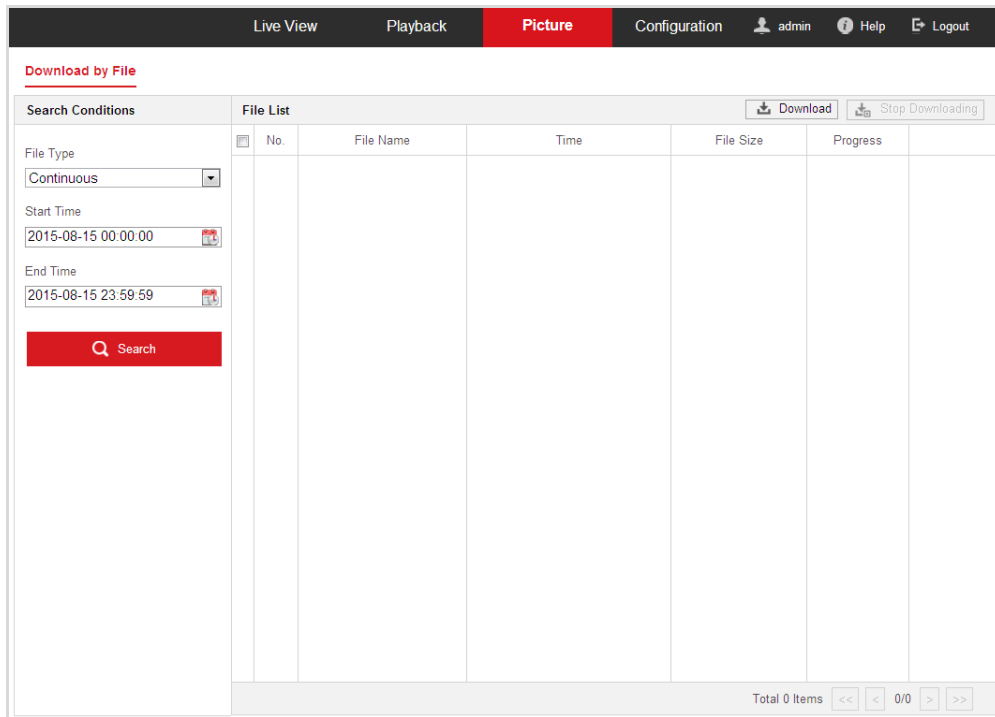

Figure 5-11 Picture Interface

2. Select the file type of capturing the pictures from the list as timing, alarm, motion, etc.
3. Set the start time and end time. Click **Search**. The corresponding picture files will be listed.
4. Check the checkbox in front of the files that you need to download.
5. Click **Download** to download the files.

5.3 Playback

Purpose:

This section explains how to view the remotely recorded video files stored in the memory card or network disks.

5.3.1 Play Back Video Files

Steps:

1. Click **Playback** on the menu bar to enter playback interface.

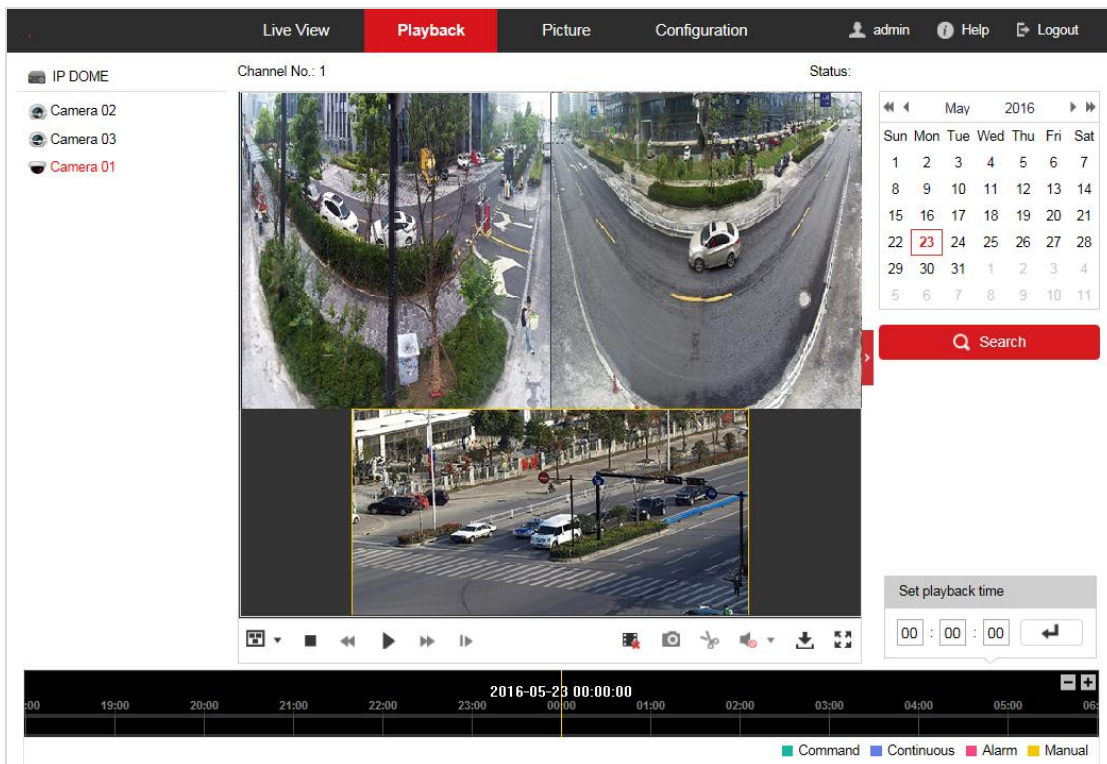

Figure 5-12 Playback Interface

2. Select the date and click

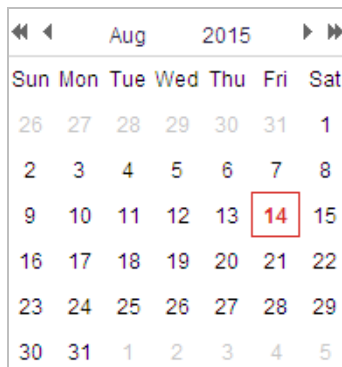

Figure 5-13 Search Video



3. Click  to play the video files found on this date.

The toolbar on the bottom of Playback interface can be used to control playing process.



Figure 5-14 Playback Toolbar











Descriptions of Icons on PTZ Control Panel are listed below:

Playback  Click  to start playback and the icon turns into . Click the icon again to stop playback.



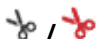

Stop All Playback

Click  to stop all channels's playback at once.

		Single Frame Click  to start playback by frame.
Playing Speed		Click  to slow forward and click  to fast forward.
Capture a picture		Click  to manually capture the picture.
Clip		Click  to start clipping video file and the icon turns into  . Click the icon again to stop clipping.
Download		Click  to download the video file.

Note:

You can choose the file paths locally for downloaded playback video files and pictures in Local Configuration interface. Refer to **Section 2.1 Local Configuration Interface** for details.

Drag the progress bar with the mouse to locate the exact playback point. You can also input the time and click  to locate the playback point in the **Set playback time** field. You can also click  to zoom out/in the progress bar.

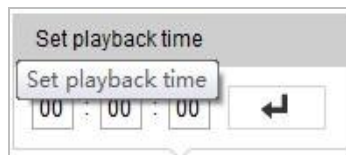

Figure 5-15 Set Playback Time

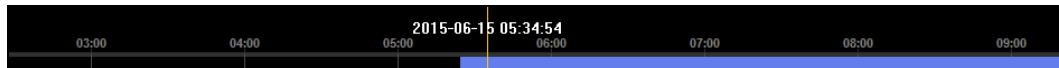

Figure 5-16 Progress Bar

The different colors of the video on the progress bar stand for the different video types as shown in Figure 5-17.

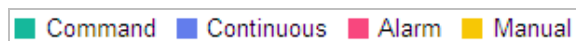



Figure 5-17 Video Types

5.3.2 Downloading Video Files

Steps:

1. Click  on the playback interface. The pop-up menu is shown in Figure 5-18.
2. Set the start time and end time. Click **Search**. The corresponding video files will be listed.

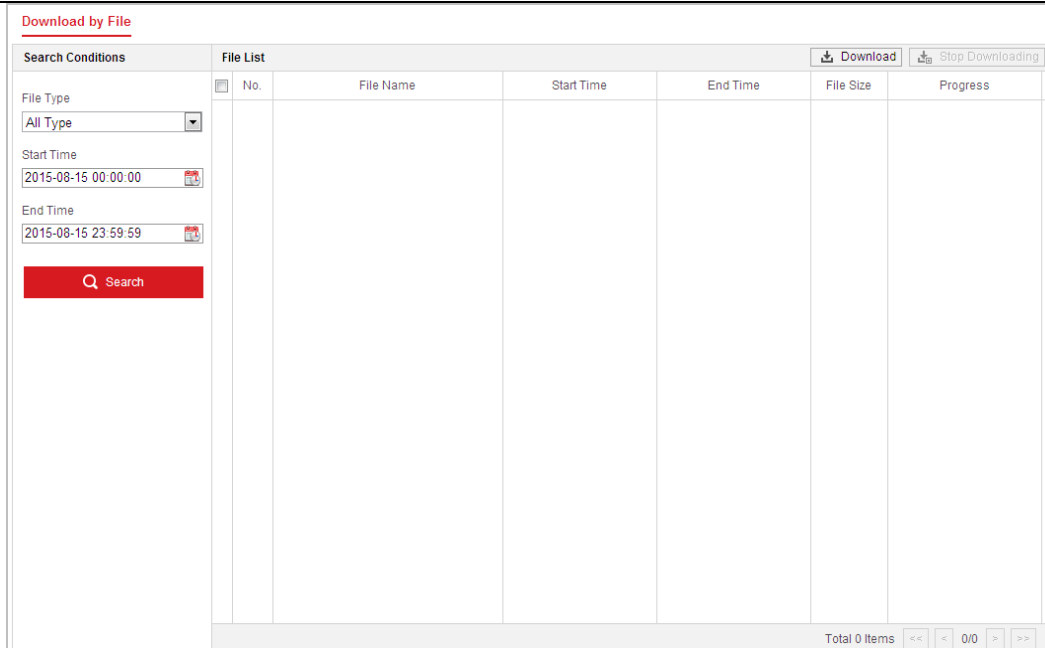



Figure 5-18 Video Downloading interface

3. Check the checkbox in front of the video files that you need to download.
4. Click  **Download** to download the video files.

Chapter 6 Alarm and Events

Purpose:

This section explains how to configure the camera to respond to alarm events, including motion detection, video tampering, video loss, alarm input, alarm output, exception, and audio exception detection. These events can trigger the alarm actions, such as Send Email, Notify Surveillance Center, Upload to FTP/Memory Card/NAS, etc.

For example, when an external alarm is triggered, the camera sends a notification to an e-mail address.

6.1 Basic Event Configuration

6.1.1 Configuring Motion Detection

Purpose:

Motion detection is a feature which can trigger alarm actions and actions of recording videos when the motion occurred in the surveillance scene.

Steps:

1. Enter the motion detection setting interface:
Configuration > Event > Basic Event > Motion Detection
2. Select the camera **Channel No.** from the dropdown list.

Note:

The Camera 1 is the PTZ channel, and the Camera 2 and Camera 3 are the panoramic view channels.

3. Check the **Enable Motion Detection** checkbox to enable this function.
You can check the **Enable Dynamic Analysis for Motion** checkbox if you want the detected object get marked with rectangle in the live view.
4. Select the configuration mode as *Normal* or *Expert* and set the corresponding motion detection parameters.

● **Normal**

Steps:

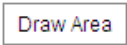
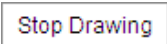
- (1) Click . Drag the mouse on the live video image to draw a motion detection area.
- (2) Click  to finish drawing.

Notes:

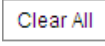
- You can draw up to 8 motion detection areas on the same image.
- You can click  to clear all of the areas.

- (3) Move the slider  to set the sensitivity of the detection.

Figure 6-1 Motion Detection Settings-Normal

- **Expert**

Figure 6-2 Motion Detection Settings-Expert

Steps:

- (1) Set the **Scheduled Image Settings**, there are OFF, Auto-Switch and Scheduled-Switch selectable. If the switch mode is enabled, you can configure the detection rule for the day and night separately.

OFF: Disable the day and night switch.

Auto-Switch: Switch the day and night mode according to the illumination automatically.

Scheduled-Switch: Switch to the day mode at 6:00 a.m., and switch to the night mode at 18:00 p.m.

(2) Select **Area** to configure in the dropdown list.

(3) Set the values of **Sensitivity** and **Percentage**.

Sensitivity: The greater the value is, the easier the alarm will be triggered.

Percentage: When the size proportion of the moving object exceeds the predefined value, the alarm will be triggered. The less the value is, the easier the alarm will be triggered.

5. Set the Arming Schedule for Motion Detection.

(1) Click **Arming Schedule** tab to enter the arming schedule setting interface.



Figure 6-3 Arming Schedule

(2) Select the timeline of a certain day, and drag the mouse to set the arming schedule (the start time and end time of the arming task).

(3) After you set the scheduled task, you can click  and copy the task to other days (optional).

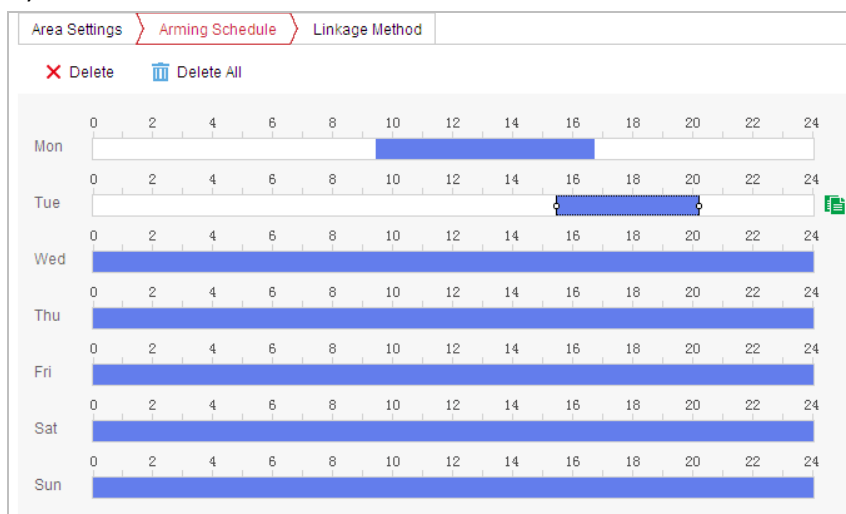

Figure 6-4 Arming Time Schedule

- (4) After setting the arming schedule, you can click a segment to display the segment arming settings interface to edit the segment record parameters (optional).



Figure 6-5 Segment Arming Settings

- (5) Click  to save the settings.

Note:

The time of each period cannot be overlapped. Up to 8 periods can be configured for each day.

6. Set the Alarm Actions for Motion Detection.

Click  tab to enter the **Linkage Method** interface.

You can specify the linkage method when an event occurs. The following contents are about how to configure the different types of linkage method.

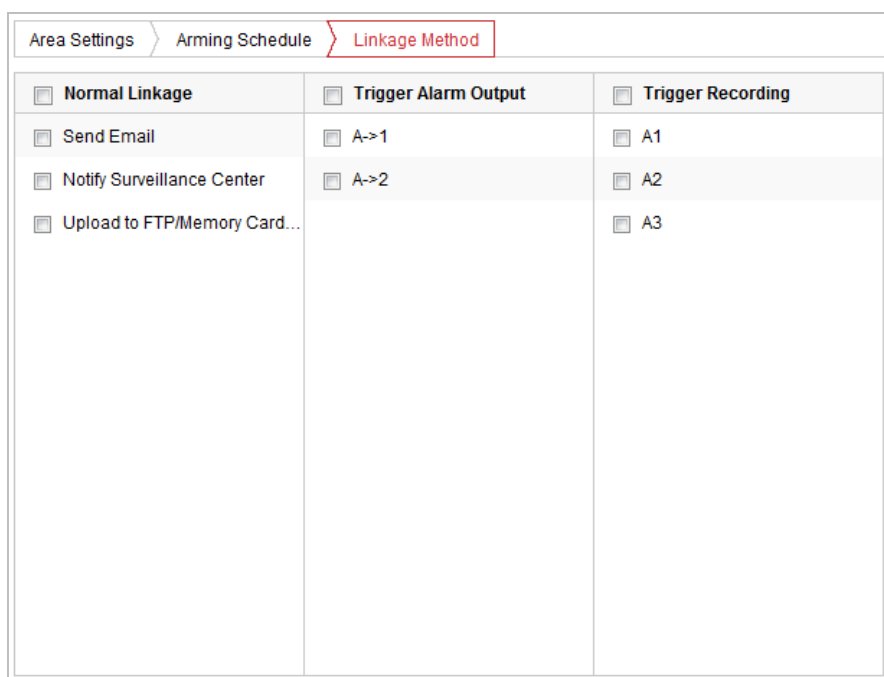

Figure 6-6 Linkage Method

Check the checkbox to select the linkage method. Send Email, Notify Surveillance Center, Upload to FTP/Memory Card/NAS, Trigger Alarm Output and Trigger Recording are selectable.

● **Send Email**

Send an email with alarm information to a user or users when an event occurs.

Note:

- To send the Email when an event occurs, you need to refer to **Section 2.2.2 Advanced Settings - Configuring Email Settings** to set the Email parameters.

● **Notify Surveillance Center**

Send an exception or alarm signal to remote management software when an event occurs.

● **Upload to FTP/Memory Card/NAS**

Capture the image when an alarm is triggered and upload the picture to a FTP server.

Note:

You need a FTP server and set FTP parameters first. Refer to **Section 2.2.2 Advanced Settings - Configuring FTP Settings** for setting FTP parameters.

● Trigger Channel

Record a video when an event occurs.

Note:

You have to set the recording schedule to realize this function. Refer to **Section 5.1 Storage Settings** for settings the recording schedule.

● Trigger Alarm Output

Trigger one or more external alarm outputs when an event occurs.

Note:

To trigger an alarm output when an event occurs, refer to **Section 6.1.5 Configuring Alarm Output** to set the alarm output parameters.

6.1.2 Configuring Video Tampering Alarm

Purpose:

You can configure the camera to trigger the alarm actions when the lens is covered.

Steps:



1. Enter the video tampering settings interface:

Configuration > Event > Basic Event > Video Tampering



Figure 6-7 Tampering Alarm

2. Check the **Enable** checkbox to enable the tampering detection.
3. Set the tampering area. Refer to *Step 4* in **Section 6.1.1 Configuring Motion Detection**.

4. Click  tab to enter the arming schedule setting interface. The arming schedule configuration is the same as the setting of the arming schedule for motion detection. Refer to *Step 5* in **Section 6.1.1 Configuring Motion Detection**.
5. Click  tab to select the linkage method taken for the video loss alarm. Send Email, Notify Surveillance Center, and Trigger Alarm Output are selectable. Refer to *Step 6* in **Section 6.1.1 Configuring Motion Detection**.
6. Click  to save the settings.

6.1.3 Configuring Video Loss Alarm

Steps:

1. Enter the Video Loss setting interface:
Configuration > Event > Basic Event > Video Loss

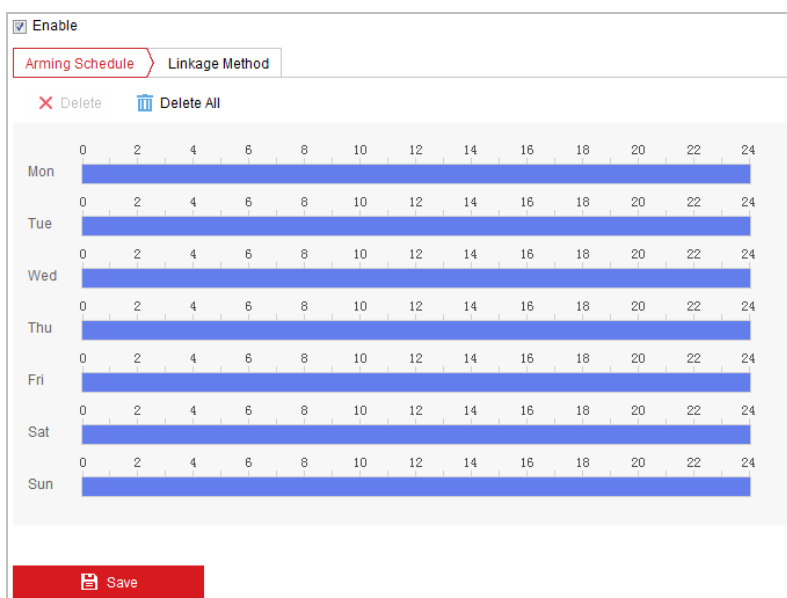
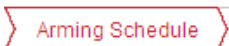



Figure 6-8 Video Loss

2. Check the **Enable** checkbox to enable the video loss detection.
3. Click  tab to enter the arming schedule setting interface. The arming schedule configuration is the same as the setting of the arming schedule for motion detection. Refer to *Step 5* in **Section 6.1.1 Configuring Motion Detection**.
4. Click  tab to select the linkage method taken for the video loss alarm. Send Email, Notify Surveillance Center, and Trigger Alarm Output are selectable. Refer to *Step 6* in **Section 6.1.1 Configuring Motion Detection**.
5. Click  to save the settings.

6.1.4 Configuring Alarm Input

Steps:

1. Enter the Alarm Input settings interface:

Configuration > Event > Basic Event > Alarm Input

2. Choose the Alarm Input No. and the Alarm Type. The alarm type can be NO (Normally Open) and NC (Normally Closed).

3. Edit the name in (cannot copy) to set a name for the alarm input (optional).

Figure 6-9 Alarm Input Settings

4. Click tab to enter the arming schedule setting interface. The arming schedule configuration is the same as the setting of the arming schedule for motion detection. Refer to *Step 5* in **Section 6.1.1 Configuring Motion Detection**.
5. Click tab to select the linkage method taken for the video loss alarm. Send Email, Notify Surveillance Center, Upload to FTP/Memory Card/NAS, Trigger Alarm Output and Trigger Recording are selectable. Refer to *Step 6* in **Section 6.1.1 Configuring Motion Detection**.
6. You can also choose the PTZ linking for the alarm input. Check the relative checkbox and select the No. to enable Preset Calling, Patrol Calling or Pattern Calling.
7. You can copy your settings to other alarm inputs.
8. Click to save the settings.

<input type="checkbox"/> Normal Linkage	<input type="checkbox"/> Trigger Alarm Output	<input type="checkbox"/> Trigger Channel	PTZ Linking A1 ▼
<input type="checkbox"/> Send Email	<input type="checkbox"/> A->1	<input type="checkbox"/> A1	<input type="checkbox"/> Preset No.
<input type="checkbox"/> Notify Surveillance Center	<input type="checkbox"/> A->2		1 ▼
<input type="checkbox"/> Upload to FTP			<input type="checkbox"/> Patrol No.
			1 ▼
			<input type="checkbox"/> Pattern
			1 ▼

Figure 6-10 Linkage Method

6.1.5 Configuring Alarm Output

Steps:

- Enter the Alarm Output settings interface:
Configuration > Event > Basic Event > Alarm Output
- Select one alarm output channel in the **Alarm Output** dropdown list.
- Set a name in (cannot copy) for the alarm output (optional).
- The **Delay** time can be set to **5sec**, **10sec**, **30sec**, **1min**, **2min**, **5min**, **10min** or **Manual**. The delay time refers to the time duration that the alarm output remains in effect after alarm occurs.
- Click tab to enter the arming schedule setting interface. The time schedule configuration is the same as the settings of the arming schedule for motion detection. Refer to **Step 5** in **Section 6.1.1 Configuring Motion Detection**.

Alarm Output No. A->1 ▼	IP Address Local
Delay 5s ▼	Alarm Name <input type="text"/> (cannot copy)
Alarm Status OFF ▼ (cannot copy)	

Mon	0 2 4 6 8 10 12 14 16 18 20 22 24
Tue	0 2 4 6 8 10 12 14 16 18 20 22 24
Wed	0 2 4 6 8 10 12 14 16 18 20 22 24
Thu	0 2 4 6 8 10 12 14 16 18 20 22 24
Fri	0 2 4 6 8 10 12 14 16 18 20 22 24
Sat	0 2 4 6 8 10 12 14 16 18 20 22 24
Sun	0 2 4 6 8 10 12 14 16 18 20 22 24

Figure 6-11 Alarm Output Settings

- You can copy the settings to other alarm outputs.
- Click  to save the settings.

6.1.6 Handling Exception

The exception type can be HDD full, HDD error, network disconnected, IP address conflicted and illegal login to the cameras.

Steps:

- Enter the Exception settings interface:
Configuration > Event > Basic Event > Exception
- Check the checkbox to set the actions taken for the Exception alarm. Refer to *Step 6* in **Section 6.1.1 Configuring Motion Detection**.

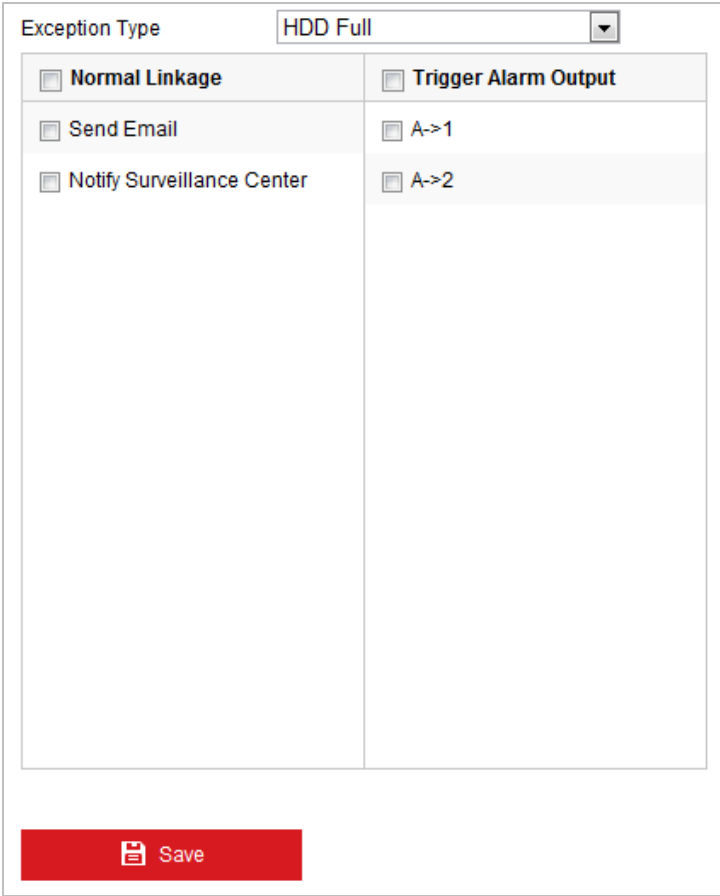

Exception Type: HDD Full	
<input type="checkbox"/> Normal Linkage	<input type="checkbox"/> Trigger Alarm Output
<input type="checkbox"/> Send Email	<input type="checkbox"/> A->1
<input type="checkbox"/> Notify Surveillance Center	<input type="checkbox"/> A->2



Figure 6-12 Exception Settings

- Click  to save the settings.

6.2 Smart Event Configuration

6.2.1 Detecting Audio Exception

Purpose:

When you enable this function and audio exception occurs, the alarm actions will be triggered.

Steps:

1. Enter the audio exception detection interface:

Configuration > Event > Smart Event > Audio Exception Detection

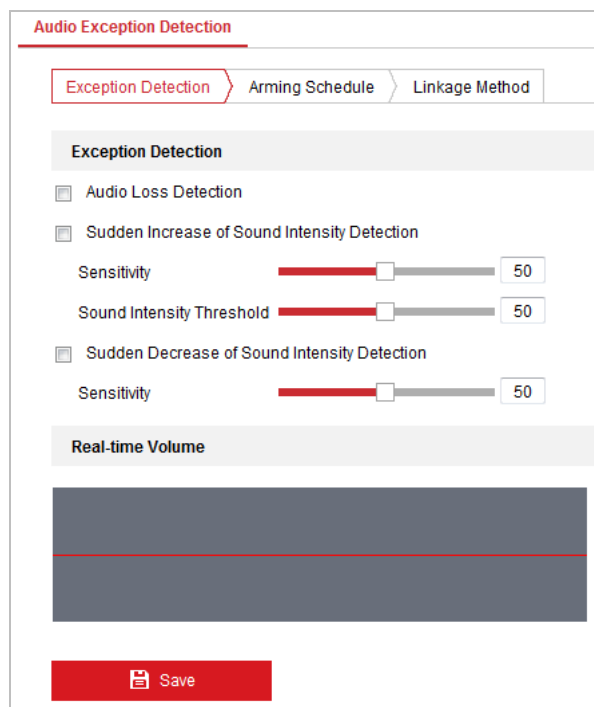

Figure 6-13 Audio Exception Detection

2. Check the **Audio Loss Detection** checkbox to enable the audio input exception detection.
3. Check the **Sudden Increase of Sound Intensity Detection** checkbox to enable the sudden rise detection.
 - **Sensitivity:** Range [1-100], the smaller the value the more severe the sound change will trigger the detection.
 - **Sound Intensity Threshold:** Range [1-100], it can filter the sound in the environment, the louder the environment sound, the higher the value should be. You can adjust it according to the actual environment.
4. Check the **Sudden Decrease of Sound Intensity Detection** checkbox to enable the sudden drop detection.

Sensitivity: Range [1-100], the smaller the value the more severe the sound change will trigger the detection.
5. Click **Arming Schedule** tab to enter the arming schedule setting interface. The time schedule configuration is the same as the settings of the arming schedule for motion detection. Refer to *Step 5* in **Section 6.1.1 Configuring Motion Detection**.
6. Click **Linkage Method** tab to select the linkage method taken for the video loss alarm. Send Email, Notify Surveillance Center, Trigger Alarm Output, and Trigger Recording are selectable. Refer to *Step 3* in **Section 6.1.1 Configuring Motion Detection**.
7. Click **Save** to save the settings.

6.3 VCA Configuration

6.3.1 VCA Configuration description

Purpose:

You can do intelligent analysis such as behavior analysis and face capture, etc. with the camera. Multiple rules can be configured for different requirements. The three VCA resource types are only available for Camera 1.

Note:

VCA function varies depending on different camera models.

Before you start:

Enter the VCA Resource Type configuration interface:

Configuration > VCA

Select Camera 1 from the dropdown list and click **VCA Info**: Behavior Analysis, Face Capture, and Behavior Analysis & Face Capture are selectable as the VCA type for Camera 1.

Select Camera 2 or Camera 3 from the dropdown list: only **Overlay & Capture**, **Shield Region**, **Rule**, and **Advanced Configuration** are configurable.

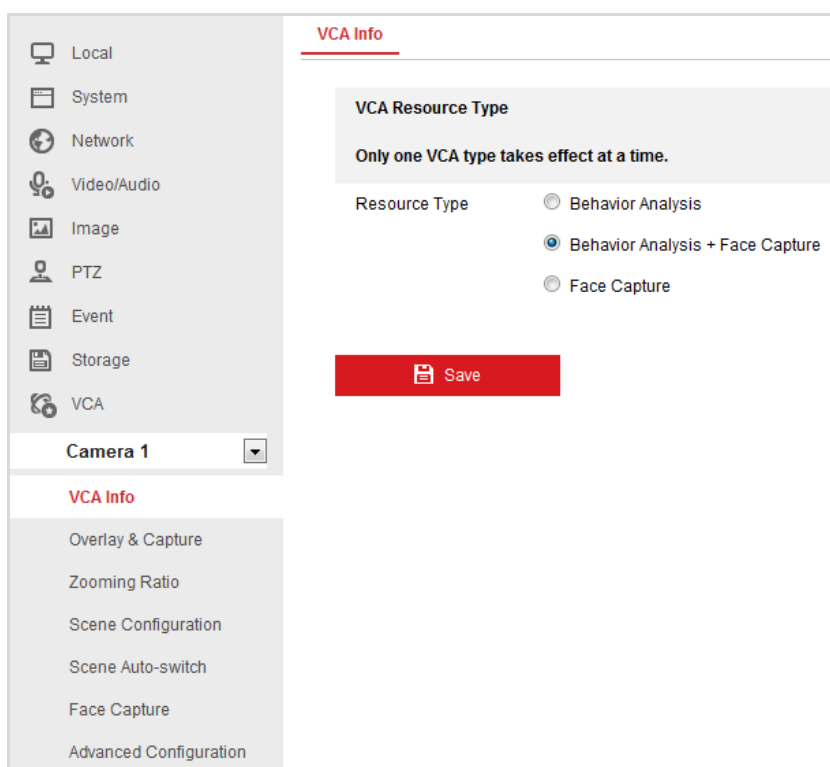

Figure 6-14 VCA Configuration (Camera 1)

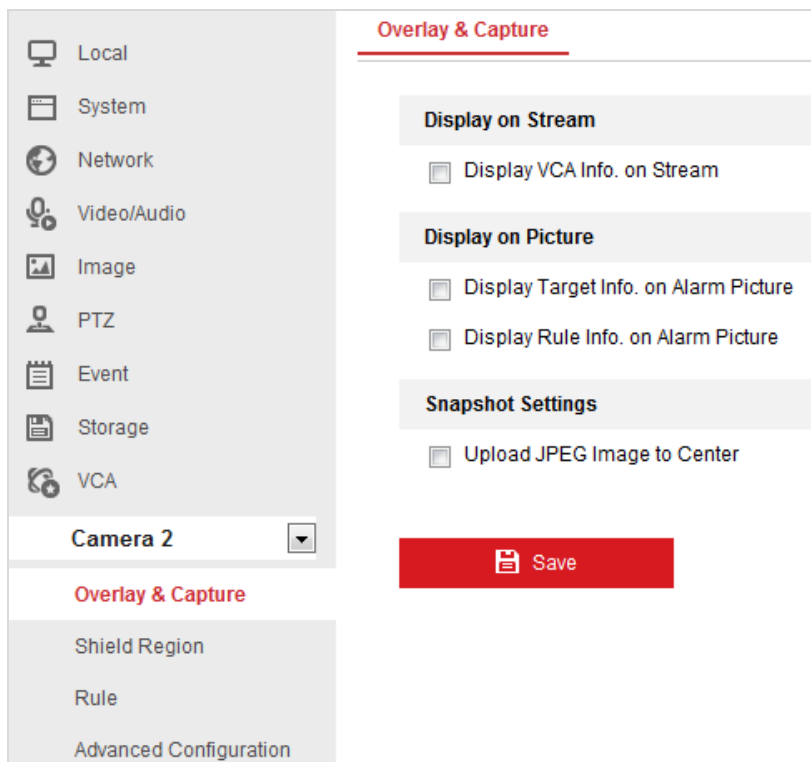

Figure 6-15 VCA Configuration (Camera 2 and Camera 3)

The setting of VCA configuration can be divided into three modes.

- **Behavior Analysis Configuration**

For the configuration of behavior analysis, refer to the flowchart below.

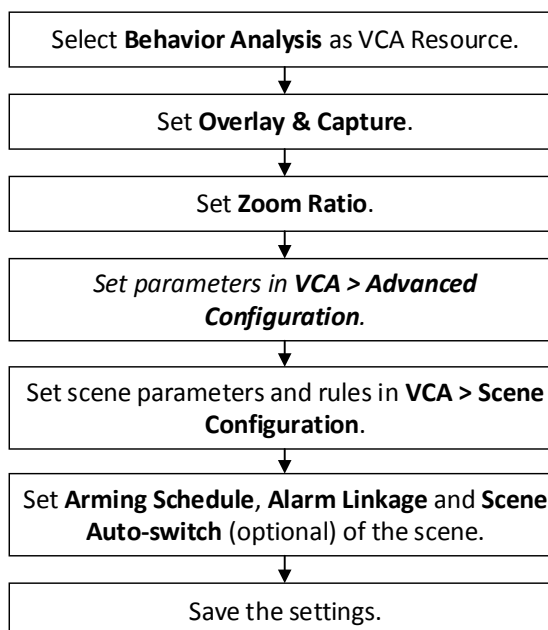

Figure 6-16 Flowchart of Configuring Behavior Analysis

- **Behavior Analysis & Face Capture Configuration**

For the configuration of behavior analysis & face capture, refer to the flowchart below.

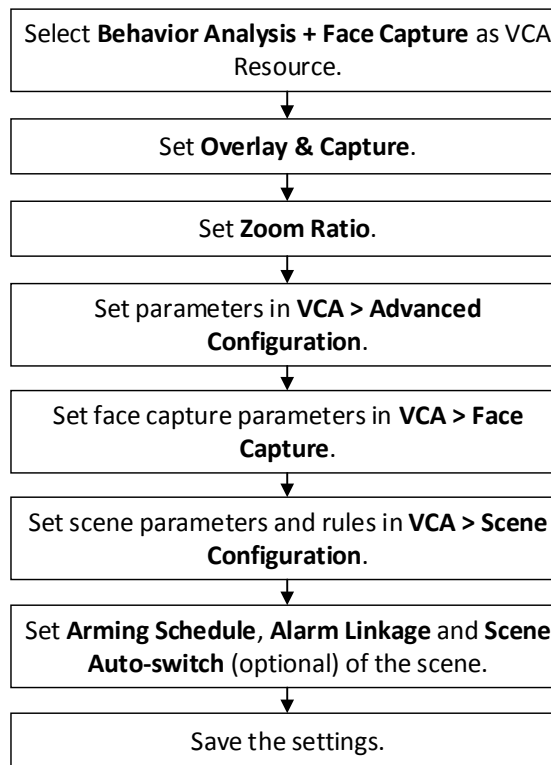

Figure 6-17 Flowchart of Configuring Behavior Analysis & Face Capture

● Face Capture Configuration

For the configuration of face capture, refer to the flowchart below.

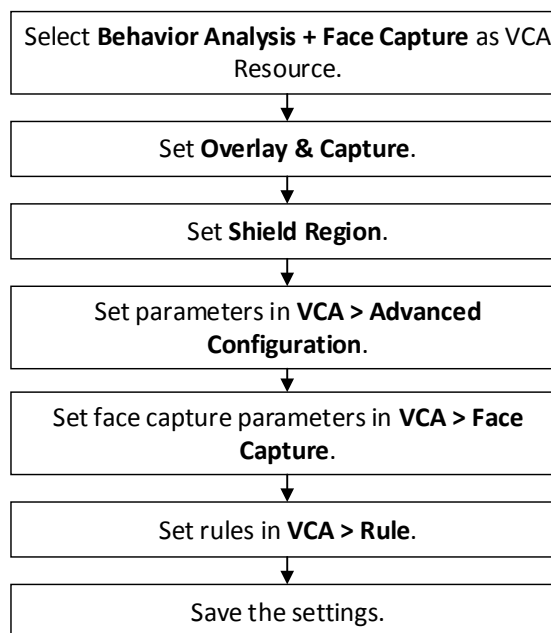

Figure 6-18 Flowchart of Configuring Face Capture

6.3.2 Configuring VCA Information (Overlay & Capture)

Steps:

1. Enter the VCA configuration interface:
Configuration > VCA > Overlay & Capture

Overlay & Capture

Intelligent Analysis

Display on Stream

Display VCA Info. on Stream

Display on Picture

Display Target Info. on Alarm Picture

Display Rule Info. on Alarm Picture

Snapshot Settings

Upload JPEG Image to Center

Picture Quality: High

Picture Resolution: 1080P(1920*1080)



 Save

Figure 6-19 Overlay & Capture

2. Check the check box to enable the Intelligent Analysis. And you can check the current version for the selected VCA analysis module.
3. Set the display information:
 - If you select to display the target info and rule info on the alarm picture are supported; you can enable the functions by checking the corresponding checkbox on your demand.
 - And if you check the checkbox of display target info and rule on stream, the information will be added to the video stream, and the overlay will be displayed if you get live view or play back by the VS Player.
4. Set the Snapshot:
 - You can check the checkbox to upload JPEG image to surveillance center when VCA alarm occurs.
 - You can also set the quality and resolution of the picture separately.
5. Click  Save to save the settings.

6.3.3 Zooming Ratio

Steps:

1. Enter the Zooming Ratio settings interface:
Configuration > VCA > Zooming Ratio
2. Configure the **Zoom Ratio** parameters: Set the appropriate tracking zooming ratio with the PTZ control panel.

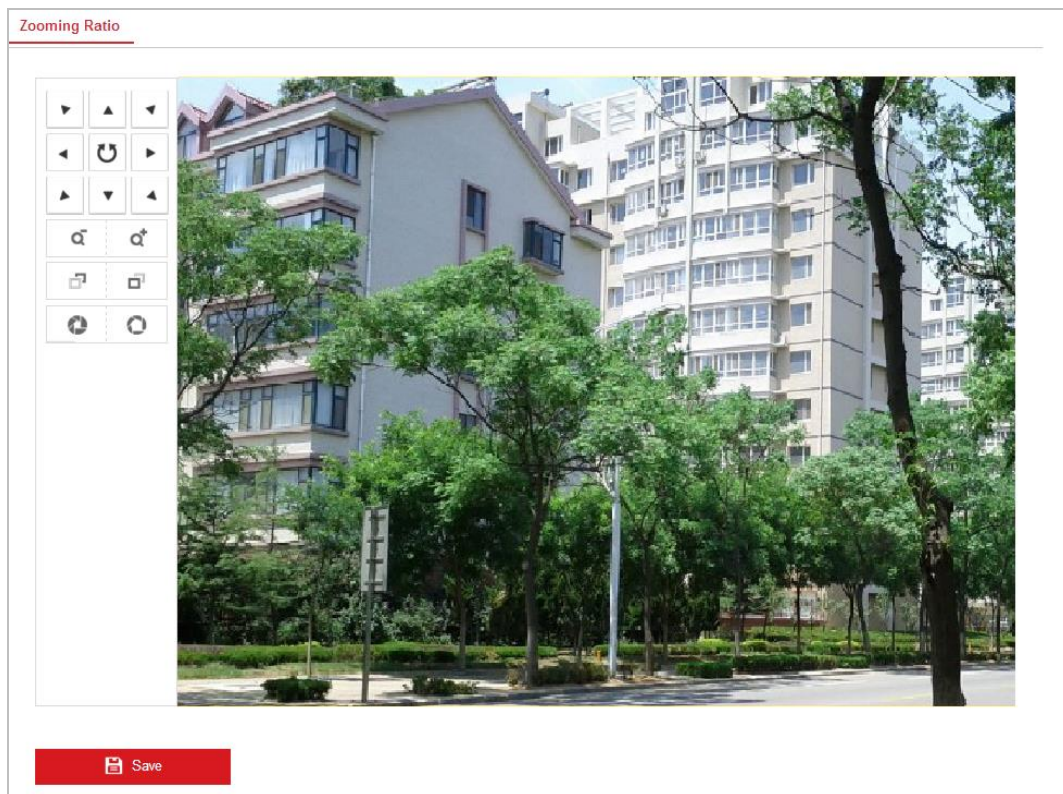

Figure 6-20 Zoom Ratio

3. Click  to save the settings.

6.3.4 Advanced Configuration

Purpose:

All the parameters for both behavior analysis and face capture are collected in the advanced configuration page. You can configure these parameters for different VCA types on your demand.

Steps:

1. Enter the Advanced Configuration interface:
Configuration > VCA > Advanced Configuration

Figure 6-21 Advanced Configuration

- Adjust the Detection Parameters. (When VCA resource is selected as Behavior Analysis/Behavior Analysis + Face Capture.)

Detection Sensitivity: Range [0-4], the higher the sensitivity is, the easier the target will be detected.

Background Update Rate: Range [0-4], if a detected target remains in the monitoring scene for a certain time, the system will count the target as the background automatically. The greater the value is, the faster the target will be counted as the background.

Minimum Target Size: Range [0-4], The system will filter out the object smaller than the minimum target size.

Displacement Constraint for Target Generation: Range [0-4], the higher the value is, the slower the target is generated, and the higher accuracy the analysis will get.

Light Change Suppression: Check the checkbox to suppress the impact caused by the illumination change.

- Adjust the Tracking Parameters. (When VCA resource is selected as Behavior Analysis/Behavior Analysis + Face Capture.)

Post-tracking: Range [2-600], you can configure the tracking duration after the target is still.

Force Tracking: Check the checkbox to enable the function to prevent the object to be blocked. After the function being enabled, the camera will continue locating and tracking the blocked target.

Grade Threshold for Stopping Tracking: Range [1-15], the higher the value is, the network camera stops tracking under higher condition.

Stop Tracking after Face Detected: You can set the tracking stopping threshold. The higher the value is the, the easier the tracking can be stopped.

Restore Default: Click **Restore** to restore the parameters to the default.

Restart VCA: Click **Restart** to restart the VCA function.

4. Adjust the Capture Parameters. (When VCA resource is selected as Face Capture.)

Generation Speed: Range [1-5], the speed for generating the target frame (green) when the person enters the detection region. If you increase this parameter, the target will generate faster and also the false detection rate will rise. In general, it is recommended to use the default value.

Capture Times: Range [1-10], the times for capturing the person who passes through the detection region. If the person passes very fast, the capture times may be less than the set parameter.

Sensitivity: Range [1-5], the sensitivity for face detection. Larger value means higher sensitivity, more faces will be detected and also false detection rate will rise. In general, it is recommended to use the default value. Decrease the value if the false detection rate is high.

Capture Interval: Range [1-255], the interval between two capture actions.

Capture Sensitivity: Range [0-20], the threshold for judging whether to do face capture.

5. Click  to save the settings.

6.3.5 Scene Configuration

Purpose:

The network camera supports patrol tracking for multiple scenes. At most 10 scenes can be supported by the network camera. At most 8 rules can be configured for a single scene. You can configure the rules for the scene on your demand.

Steps:

1. Enter the Scene Configuration interface:
Go to **Configuration > VCA > Scene Configuration**.
2. Create a scene. (Optional)
 - **Create a Scene:**
 - 1) Add New Scene: Click **New Scene** to create a new scene.
 - 2) Control the PTZ to get the required scene.
 - 3) Set the scene parameters.
 - 4) Click  to save the settings.
 - 5) After saving the scene position, you can click **Call** to call the scene position.
3. Select a scene to enter the scene VCA configuration interface.
4. You can configure the scene parameters, rule, arming schedule and alarm linkage.

Scene Parameters

Steps:

1. Enter Scene Parameters settings interface (here we take Scene 1 as an example):
Configuration > VCA > Scene Configuration > Scene 1 > Scene Parameters

Figure 6-22 Scene Parameters Interface

- Set the scene parameters.

Scene Name: Enter a custom scene name.

Duration: Set the dwell time of the scene when doing patrol tracking. The intelligent analysis will be enabled during the period. If the alarm is triggered, the network camera will start to track automatically.

Enable Track: Check the checkbox to enable the tracking function for the scene.

Tracking Duration: Set the duration of the tracking. If the value is selected as 0, the tracking duration will not be limited.

Limited Tracking: You can check the checkbox to enable/disable the function. If the function is enabled, you can set the limited position for the tracking.

Note:

After saving the scene position and auto-tracking limits, you can click **Call** to view the saved position or limits.

- Click  Save to save the settings.

Rule

Purpose:

At most 8 rules can be configured for a single scene. Follow the steps below to configure the rule for the scene.

Steps:

- Enter the Rule setting interface:
Configuration > VCA > Scene Configuration > Scene 1 > Rule
- Create new rule: Click  to add a new rule.
- Select rule type: Click the dropdown list to select the rule type. Line Crossing, Intrusion, Region Entrance, and Region Exiting are selectable.

Enable	No.	Rule Name	Rule Type
<input checked="" type="checkbox"/>	1	RULE1	Intrusion
<input checked="" type="checkbox"/>	2		None

Filter by Pixel
 Max. Size: 0 * 0
 Min. Size: 0 * 0

Figure 6-23 Rule List

4. Configure the rule area: Click **Draw Line** or **Draw Area** on the tool bar of the live view panel. Click the mouse on the live view panel. Right click the mouse to finish drawing. For details, refer to **Section 6.3.9 Rule Configuration Demonstration**.
5. Configure the filtering size: The filtering function is reserved. You can set the minimum and maximum size of the object needs to be filtered in **Section 6.3.4 Advanced Configuration**.
6. Enable rules: Check the **Enable** checkbox of each rule in the rule list to enable the rule.
7. Click  to save the settings.

Note:

Create multiple rules: You can create more rules by repeating the above steps.

Arming Schedule

Steps:

11. Enter the Arming Schedule settings interface:

Configuration > VCA > Scene Configuration > Scene > Arming Schedule

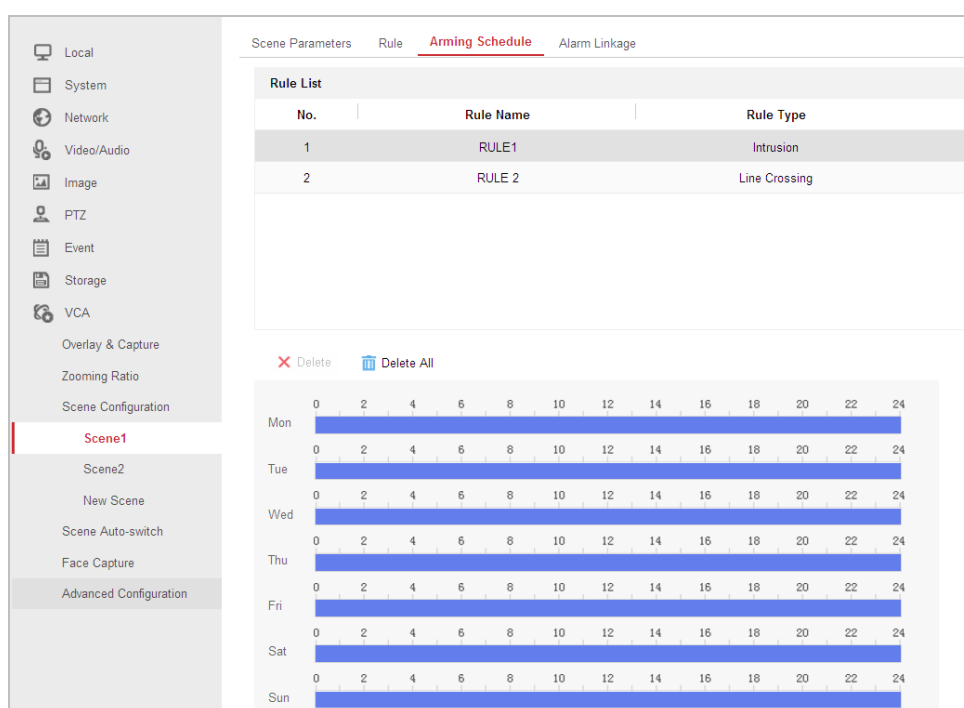



Figure 6-24 VCA Arming Schedule Interface

12. The saved rules will be listed in the rule list. Click to select a rule to set the arming schedule.
13. Select the timeline of a certain day, and drag the left button of the mouse to set the arming schedule (the start time and end time of the recording task).
14. After you set the scheduled task, you can click  and copy the task to other days (optional).
15. After setting the arming schedule, you can click an arming segment to display the segment arming settings interface to edit the segment arming parameters. (optional)

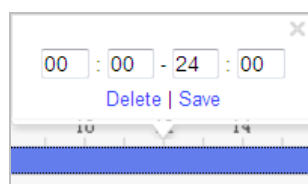

Figure 6-25 Segment Arming Settings

16. Click  to save the settings.

Note:

You can select to copy the settings to whole week or are specific days of the week. At most 8 segments can be configured.

Alarm Linkage

Steps:

1. Enter the Alarm Linkage settings interface:

Configuration > VCA > Scene Configuration > Scene > Alarm Linkage

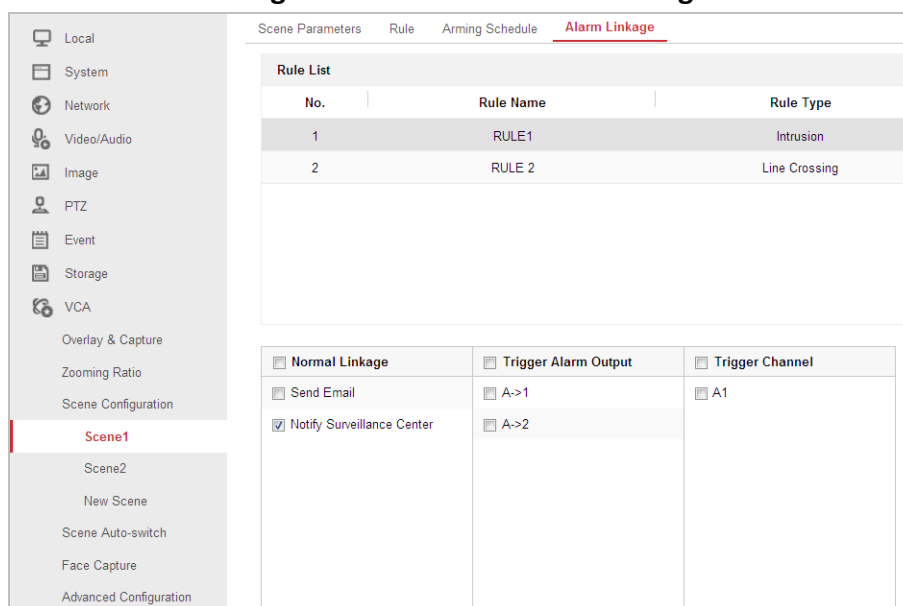



Figure 6-26 Alarm Linkage Interface

2. Select a rule from the rule list.
3. Check the checkbox of corresponding linkage actions to enable it.
4. Click  to save the settings.

6.3.6 Scene Auto-switch

Purpose:

You can set the sequence for the scene when doing patrol tracking (at least one scene is required to enable scene auto-switch).

Steps:

1. Enter the Scene Auto-switch interface:

Configuration > VCA > Scene Auto-switch.

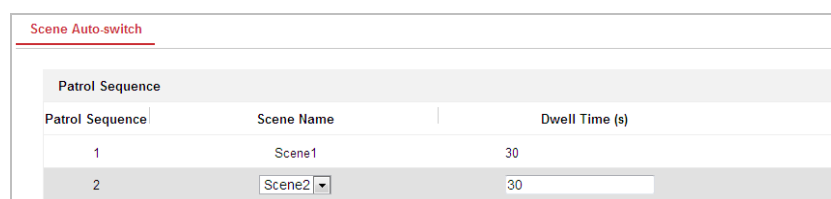



Figure 6-27 Scene Auto-switch Interface

2. Select scene name from the dropdown list and input the dwell time.
3. You can click  and  to move up and down the scene of the patrol sequence list.

Note:

If the sequence is selected as 0, this scene will not be configured for patrol tracking.

5. Click  to save the settings.

6.3.7 Face Capture

Steps:

1. Select Face Capture/Behavior Analysis & Face Capture as VCA resource.
 - 1) Go to **System > System Settings > VCA Resource**.
 - 2) Select the Face Capture/Behavior Analysis & Face Capture as the intelligent resource.
 - 3) Click  to save the settings.
2. Enter the Face Capture interface:
Configuration > VCA > Face Capture
3. Configure **Face Capture** parameters:
Check the check box to enable the function of face capture.

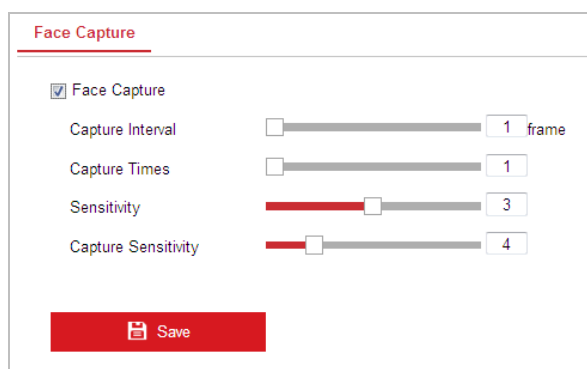

Figure 6-28 Face Capture

Capture Interval: Range [1-255], the interval between two capture actions.

Capture Times: Range [1-10], the times for capturing the person who passes through the detection region. If the person passes very fast, the capture times may be less than the set parameter.

Sensitivity: Range [1-5], the sensitivity for face detection. Larger value means higher sensitivity, more faces will be detected and also false detection rate will rise. In general, it is recommended to use the default value. Decrease the value if the false detection rate is high.

Capture Sensitivity: Range [0-20], the threshold for judging whether to do face capture.

4. Click  to save the settings.

6.3.8 Shield Region

Steps:

1. Get the Behavior Analysis interface:

Go to **VCA Configuration.> VCA Resource**. Select the Face Capture as the intelligent resource.

Click **Save** to save the settings.

2. Configure the **VCA Info**: For details, see 6.2 VCA Information.

3. Configure the **Shield Region**:

The system will shield the meaningless region to reduce the environment impact and to improve the detection accuracy.

Note:

At most 4 regions can be configured.

Steps:

1) Rotate the network camera to the required scene by control the PTZ key board.

2) Click  on the tool bar of the live view panel. Click the mouse to draw a region on the live view panel. Right click the mouse to finish.

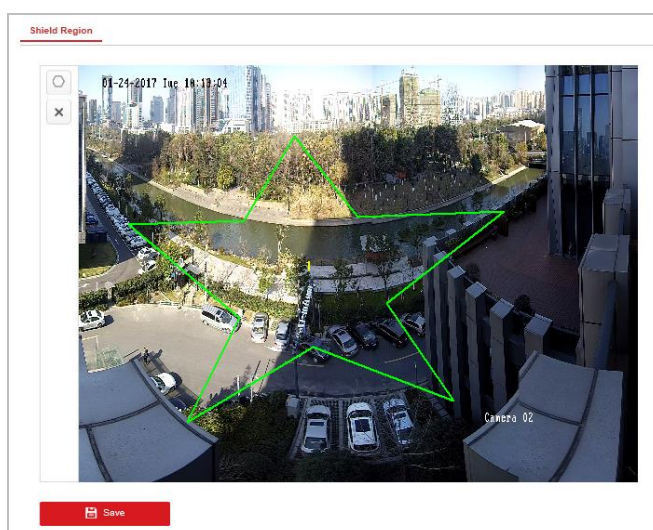

Figure 6-29 Shield Region

3) Click  to save the settings.

4. Configure **Rule** Parameters:

You can set the detection area for the scene. The system will only detect and analyze objects in the configured area.

Steps:

1) Enable Rule: Check the checkbox to enable the Face Capture rule.

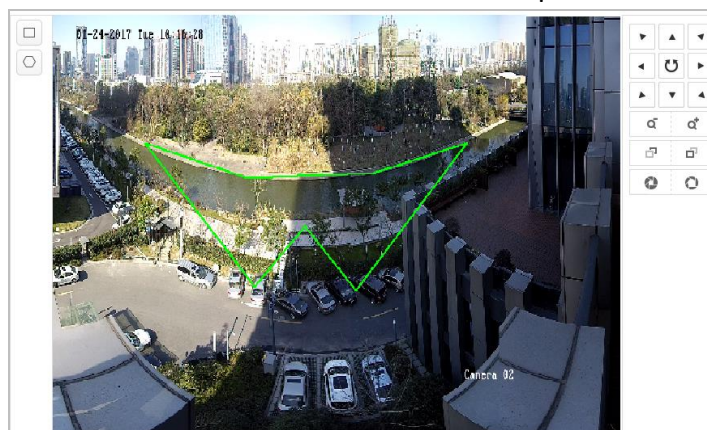





Figure 6-30 Draw Area

- 2) Draw the Detection Area: Click  on the tool bar of the live view panel. Click the mouse to draw an area on the live view panel. Right click the mouse to finish. Click **Save** to save the settings.
- 3) Draw the Minimum Pupil Distance: Click  on the tool bar of the live view panel. Drag the mouse to draw a pupil distance on the live view panel. The system will filter the objects with a pupil distance which is less than the configured value.
- 4) Click  to save the settings.

6.3.9 Rule Configuration Demonstration

This section provides detailed configuration steps for each rule.

Line Crossing

Purpose:

This function can be used for detecting people, vehicles and objects traversing a set virtual plane. The traversing direction can be set as bidirectional, from left to right or from right to left. The alarm will be triggered if the rule is broken.

Steps:

1. Create new rule: Click  add a new rule.
2. Select rule type: Click the dropdown list and select **Line Crossing** as the rule type.

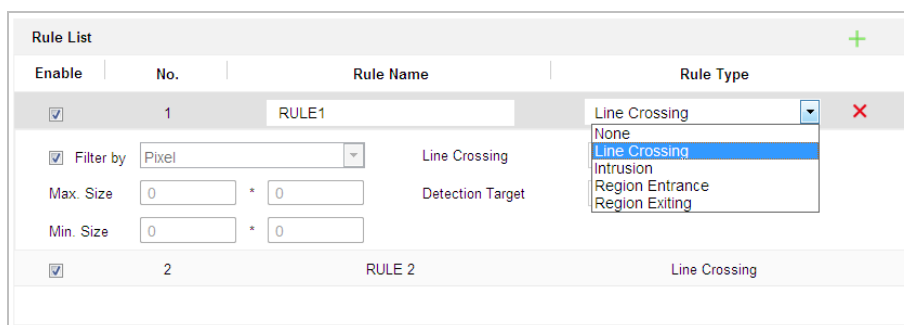

Figure 6-31 Select Rule Type

3. Configure the rule area:

Click  on the tool bar of the live view panel. Adjust the position and length of the line on the live view panel.



Figure 6-32 Draw Line

- Click the dropdown list in the rule list to select the crossing direction.

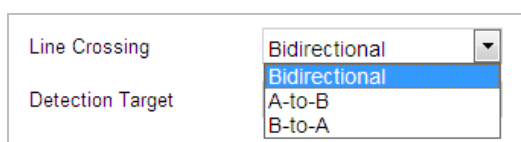



Figure 6-33 Select Crossing Direction

- Enable rules: Check the **Enable** checkbox of each rule in the rule list to enable the rule.
- Click  Save to save the settings.

Intrusion

Purpose:

This function can be used for detecting whether there are people, vehicles and objects intrude into the pre-defined region longer than the set duration. The alarm will be triggered if the rule is broken.

Steps:

- Create new rule: Click  add a new rule.
- Select rule type: Click the dropdown list and select **Intrusion** as the rule type.

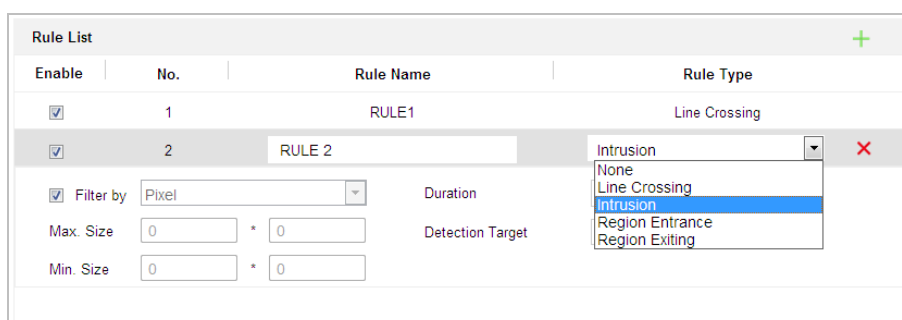

Figure 6-34 Select Rule Type

3. Configure the rule area:



Click  on the tool bar of the live view panel. Click the mouse on the live view panel. Right click the mouse to finish drawing.



Figure 6-35 Draw Area

4. Set the duration from 1to 100.
5. Enable rules: Check the **Enable** checkbox of each rule in the rule list to enable the rule.
6. Click  Save to save the settings.

Region Entrance

Purpose:

This function can be used for detecting people, vehicles and objects entering the pre-defined region. The alarm will be triggered if the rule is broken.

Steps:

1. Create new rule: Click  to add a new rule.
2. Select rule type: Click the dropdown list and select **Region Entrance** as the rule type.

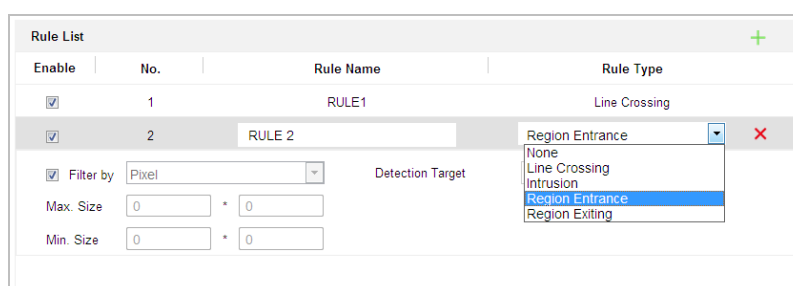

Figure 6-36 Select Rule Type

3. Configure the rule area:



Click  on the tool bar of the live view panel. Click the mouse on the live view panel. Right click the mouse to finish drawing.



Figure 6-37 Draw Area

4. Enable rules: Check the **Enable** checkbox of each rule in the rule list to enable the rule.
5. Click  Save to save the settings.

Region Exiting

Purpose:

This function can be used for detecting people, vehicles and objects exiting the pre-defined region. The alarm will be triggered if the rule is broken.

Steps:

1. Create new rule: Click  to add a new rule.
2. Select rule type: Click the dropdown list and select **Region Exiting** as the rule type.

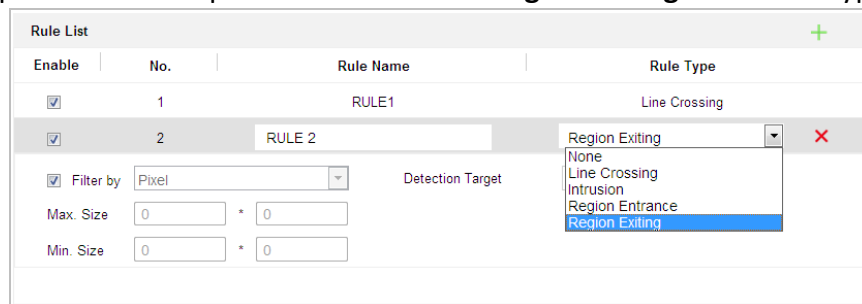

Figure 6-38 Select Rule Type

3. Configure the rule area:



Click  on the tool bar of the live view panel. Click the mouse on the live view panel. Right click the mouse to finish drawing.



Figure 6-39 Draw Area

4. Enable rules: Check the **Enable** checkbox of each rule in the rule list to enable the rule.
5. Click  to save the settings.

Chapter 7 Maintenance

7.1 System Setting

7.1.1 Viewing Basic Information

Enter the **Basic Information** interface:

Configuration > System > System Settings > Basic Information

In the **Basic Information** interface, you can edit the Device Name and Device No.

Other information of the camera, such as Model, Serial No., Firmware Version, Encoding Version, Web Version, Plugin Version, Number of Channels, Number of HDDs, Number of Alarm Input and Number of Alarm Output are displayed. The information cannot be changed in this menu. It is the reference for maintenance or modification in future.

Basic Information	Time Settings	RS485	DST
Device Name	IP DOME		
Device No.	88		
Model	XX-XxxXxxx-X		
Serial No.	XX-XxxXxxx-XxxxXXXXXXXX		
Firmware Version	VX.X.X build XxxXXXX		
Encoding Version	VX.X build XxxXXXX		
Web Version	VX X X build XxxXXXX		
Plugin Version	VX.X.X.XX		
Number of Channels	1		
Number of HDDs	0		
Number of Alarm Input	7		
Number of Alarm Output	2		

Figure 7-1 Device Information

7.1.2 Time Settings

Purpose:

You can follow the instructions in this section to configure the time which can be displayed on the video. There are Time Zone, Time Synchronization, Daylight Saving Time (DST) functions for setting the time. Time Synchronization consists of auto mode by Network Time Protocol (NTP) server and manual mode.

To enter the Time settings interface:

Configuration > System > System Settings > Time Settings

Figure 7-2 Time Settings

◆ Configuring Time Synchronization by NTP Server

Steps:

- (1) Check the radio button to enable the **NTP** function.
- (2) Configure the following settings:

Server Address: IP address of NTP server.

NTP Port: Port of NTP server.

Interval: The time interval between the two synchronizing actions by NTP server. It can be set from 1 to 10080 minutes.

Figure 7-3 Time Sync by NTP Server



- (3) You can click  to check whether the configuration is succeeded.

Note:

If the camera is connected to a public network, you should use a NTP server that has a time synchronization function, such as the server at the National Time Center (IP Address: 210.72.145.44). If the camera is set in a customized network, NTP software can be used to establish a NTP server for time synchronization.

◆ Configuring Time Synchronization Manually

Steps:

- (1) Check the **Manual Time Sync** radio button.
- (2) Click  to set the system time from the pop-up calendar.
- (3) Click  to save the settings.

Note:

You can also check the **Sync. with computer time** checkbox to synchronize the time of the camera with the time of your computer.

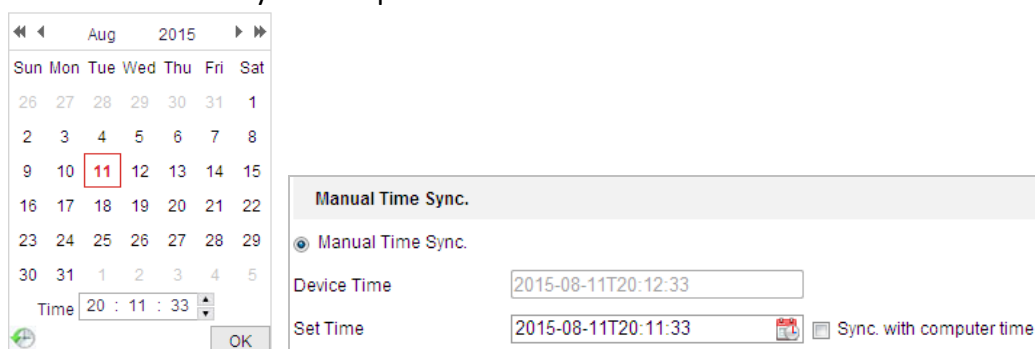

Figure 7-4 Time Sync Manually

◆ **Select the Time Zone****Purpose:**

When the camera is taken to another time zone, you can use the **Time Zone** function to adjust the time. The time will be adjusted according to the original time and the time difference between the two time zones.

From the **Time Zone** dropdown menu as shown in Figure 7-5, select the Time Zone in which the camera locates.

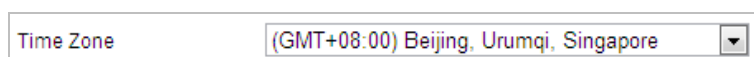

Figure 7-5 Time Zone Settings

7.1.3 Configuring RS-485

Purpose:

The RS-485 serial port is used to control the PTZ of the camera. The configuring of the PTZ parameters should be done before you control the PTZ unit.

Steps:

1. Enter RS-485 Port setting interface:

Configuration > System > System Settings > RS-485

RS485	
Baud Rate	9600
Data Bit	8
Stop Bit	1
Parity	None
Flow Ctrl	None
PTZ Protocol	PELCO-D
PTZ Address	0

Save

Figure 7-6 RS-485 Settings

2. Set the RS-485 parameters and click  to save the settings.

Note:

The Baudrate, PTZ Protocol and PTZ Address parameters of the camera should be exactly the same as those of the control device.

7.1.4 Configuring DST (Daylight Saving Time)

Purpose:

If there is the habit of adjusting clocks forward in your country in certain time period of a year, you can turn this function on. The time will be adjusted automatically when the Daylight Saving Time (DST) comes.

Steps:

1. Enter the DST settings interface:
Configuration > System > System Settings > DST
2. Check **Enable DST** to enable the DST function.
3. Set the date of the DST period.
4. Click  to save the settings.

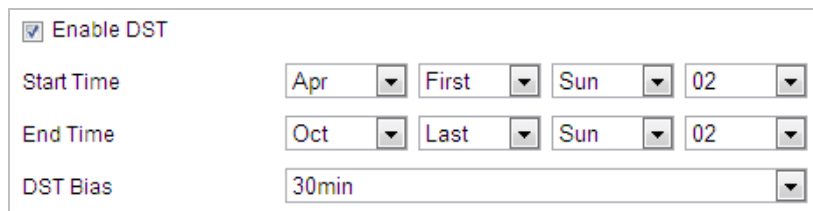

The screenshot shows the DST Settings configuration window. At the top, there is a checked checkbox labeled "Enable DST". Below this, there are three rows of settings, each with a label and a dropdown menu:

- Start Time:** Apr, First, Sun, 02
- End Time:** Oct, Last, Sun, 02
- DST Bias:** 30min

Figure 7-7 DST Settings

7.2 Maintenance

7.2.1 Upgrade & Maintenance

● Rebooting the Camera

Steps:

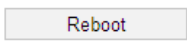
1. Enter the Maintenance interface:
Configuration > System > Maintenance > Upgrade & Maintenance:
2. Click  to remotely reboot the camera.

● Restoring Default Settings

Steps:

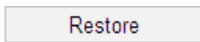
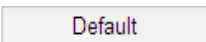
1. Enter the Maintenance interface:
Configuration > System > Maintenance > Upgrade & Maintenance:
2. Click  or  to restore the default settings.

Note:

Clicking button will restore all the parameters to default settings including the IP address and user information. Use this button with caution.

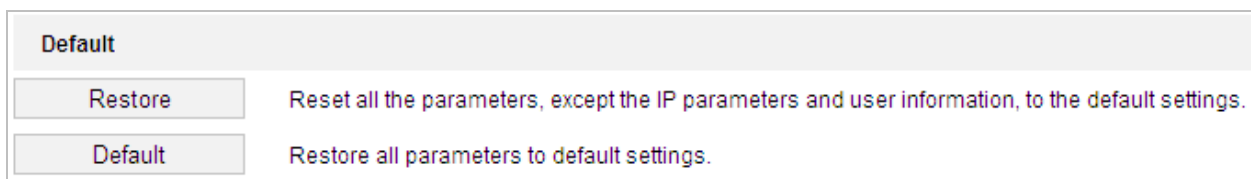

Figure 7-8 Restore Default Settings

● Exporting Configuration File

Steps:

1. Enter the Maintenance interface:

Configuration > System > Maintenance > Upgrade & Maintenance

2. Click to select the directory as the saving path to start exporting configuration file.

● Importing Configuration File

Steps:

1. Enter the Maintenance interface:

Configuration > System > Maintenance > Upgrade & Maintenance

2. Click to select the local configuration file and then click to start importing configuration file.

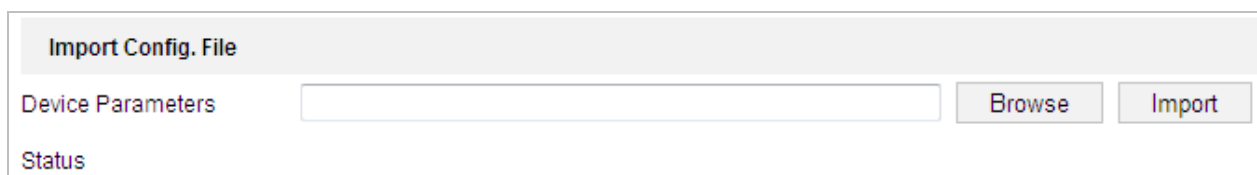

Figure 7-9 Import Configuration File

Note:

You need to reboot the camera after importing configuration file.

● Upgrading the System

Steps:

1. Enter the Upgrade & Maintenance interface:

Configuration > System > Maintenance > Upgrade & Maintenance

2. Select Firmware or Firmware Directory.

- **Firmware:** when you select **Firmware**, you need to find the firmware in your computer to upgrade the device.
- **Firmware Directory:** You need to find the directory where the firmware locates. The device can find the firmware in the directory automatically.

- Click to select the local upgrade file and then click to start remote upgrade.

Note:

The upgrading process will take 1 to 10 minutes. Do not disconnect the power of the camera during the upgrading process. The camera reboots automatically after upgrading.



Figure 7-10 Remote Upgrade

7.2.2 Log Searching

Purpose:

The operation, alarm, exception and information of the camera can be stored in log files. You can also export the log files on your demand.

Before you start:

Configure network storage for the camera or insert a memory card in the camera.

Steps:

- Enter the Log interface:

Configuration > System > Maintenance > Log

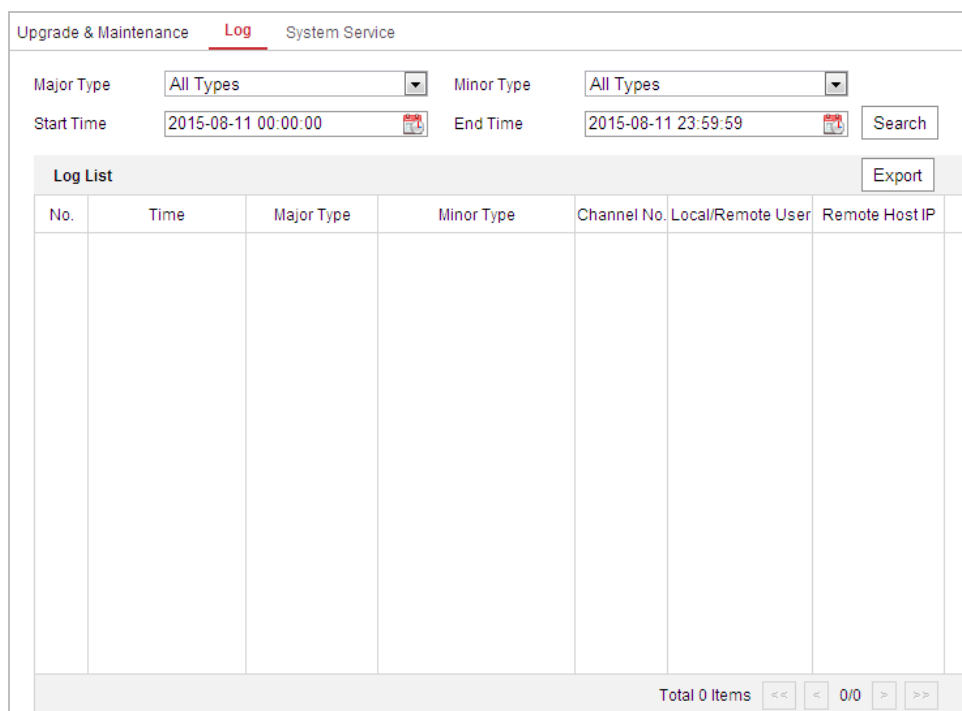

No.	Time	Major Type	Minor Type	Channel No.	Local/Remote User	Remote Host IP
Total 0 Items						

Figure 7-11 Log Searching Interface

- Set the log search conditions to specify the search, including the Major Type, Minor Type, Start Time and End Time as shown in Figure 7-11.
- Click to search log files. The matched log files will be displayed on the **Log List**.

- To export the log files, click **Save Log** to save the log files in your computer.

7.2.3 System Service

Steps:

- Enter the interface of configuring the remote connection:
Configuration > System > Maintenance > System Service
- Input a number in text field as the upper limit of the remote connection number. E.g. when you specify the remote connection number as 10, then the 11th remote connection cannot be established.



Figure 7-12 Live View Connection Settings

- Check the checkbox to enable the supplement light function, and then the light will be turned on automatically when the illumination is not enough for the video monitoring. (Optional)
- Click  to activate the settings.

Note:

The supplement light configuration is only supported by certain models.

7.3 Security

7.3.1 Configuring Authentication

Purpose:

You can specifically secure the stream data of live view.

Steps:

- Enter the Authentication interface:
Configuration > System > Security > Authentication
- Set the authentication mode for RTSP authentication.
RTSP Authentication: Select the authentication mode as basic or disable in the dropdown list to enable or disable the RTSP authentication.
- Click  to save the settings.

7.3.2 Configuring IP Address Filter

Purpose:

With this function on, the camera allows certain IP addresses whether to log in or not.

Steps:

1. Enter IP Address Filter interface:

Configuration > System > Security > IP Address Filter

The screenshot shows the IP Address Filter configuration page. At the top, there is a checkbox labeled 'Enable IP Address Filter' which is checked. Below it is a dropdown menu for 'IP Address Filter Type' with 'Forbidden' selected. A table with three columns is visible: 'No.', 'IP', and an empty space. Above the table are three buttons: 'Add', 'Modify', and 'Delete'. At the bottom of the page is a red 'Save' button.

Figure 7-13 IP Address Filter

2. Check the **Enable IP Address Filter** checkbox.
3. Select the type of IP Address Filter in the dropdown list, Forbidden and Allowed are selectable.
4. Set the IP Address Filter list.
 - Add an IP Address

Steps:

- (1) Click **Add** to add an IP.
- (2) Input the IP Address.

The screenshot shows a dialog box titled 'Add IP Address'. It has a close button (X) in the top right corner. Inside the dialog, there is a text input field labeled 'IP Address' containing the value '172.6.23.2' and a green checkmark icon to its right. Below the input field are two buttons: 'OK' and 'Cancel'.

Figure 7-14 Add an IP

- (3) Click **OK** to finish adding.

- Modify an IP Address

Steps:

- (1) Left-click an IP address from filter list and click **Modify**.
- (2) Modify the IP address in the text field.

Figure 7-15 Modify an IP

(3) Click **OK** to finish modifying.

- Delete an IP Address

Left-click an IP address from filter list and click **Delete**.

- Delete all IP Addresses

Click **Clear** to delete all the IP addresses.

5. Click **Save** to save the settings.

7.3.3 Configuring Security Service Settings

Steps:

1. Enter the Security Service interface:

Configuration > System > Security > Security Service

2. Check the **Enable SSH** checkbox to enable the SSH function.

Enable SSH: Enabling SSH (Secure Shell) function is to encrypt and compress the data and to reduce the transmission time.

7.4 User Management

Enter the User Management interface:

Configuration > System > User Management

The **admin** user has access to create, edit or delete other accounts. Up to 31 user accounts can be created.

User List			Add	Modify	Delete
No.	User Name	Level			
1	admin	Administrator			

Figure 7-16 User Information

● Add a User

Steps:

1. Click to add a user.
2. Input the new **User Name**, select **Level** and input **Password**.



- *For your privacy and to better protect your system against security risks, we strongly recommend the use of strong passwords for all functions and network devices. The password should be something of your own choosing (Using a minimum of 8 characters, including at least three of the following categories: upper case letters, lower case letters, numbers, and special characters.) in order to increase the security of your product.*
- *Proper configuration of all passwords and other security settings is the responsibility of the installer and/or end-user.*

Note:

The level indicates the permissions you give to the user. You can define the user as **Operator** or **User**.

3. In the **Basic Permission** field and **Camera Configuration** field, you can check or uncheck the permissions for the new user.
4. Click to finish the user addition.

Figure 7-17 Add a User

● Modify a User

Steps:

1. Click to select the user from the list and click .
2. Modify the **User Name**, **Level** or **Password**.

3. In the **Basic Permission** field and **Camera Configuration** field, you can check or uncheck the permissions.
4. Click to finish the user modification.

Modify user

User Name: user1

Level: Operator

Password:

Valid password range [8-16]. You can use a combination of numbers, lowercase, uppercase and special character for your password with at least two kinds of them contained.

Confirm:

Select All

- Remote: Parameters Settings
- Remote: Log Search / Interrogate Wo...
- Remote: Upgrade / Format
- Remote: Two-way Audio
- Remote: Shutdown / Reboot
- Remote: Notify Surveillance Center /...
- Remote: Video Output Control
- Remote: Serial Port Control
- Remote: Live View
- Remote: Manual Record
- Remote: PTZ Control
- Remote: Playback

OK Cancel

Figure 7-18 Modify a User

● Delete a User

Steps:

1. Click the user name you want to delete and click .
2. Click on the pop-up confirmation box to delete the user.

Appendix

Appendix 1 SADP Software Introduction

◆ Description of SADP

SADP (Search Active Devices Protocol) is a kind of user-friendly and installation-free online device search tool. It searches the active online devices within your subnet and displays the information of the devices. You can also modify the basic network information of the devices using this software.

◆ Search active devices online

● Search online devices automatically

After launch the SADP software, it automatically searches the online devices every 15 seconds from the subnet where your computer locates. It displays the total number and information of the searched devices in the Online Devices interface. Device information including the device type, IP address and port number, etc. will be displayed.

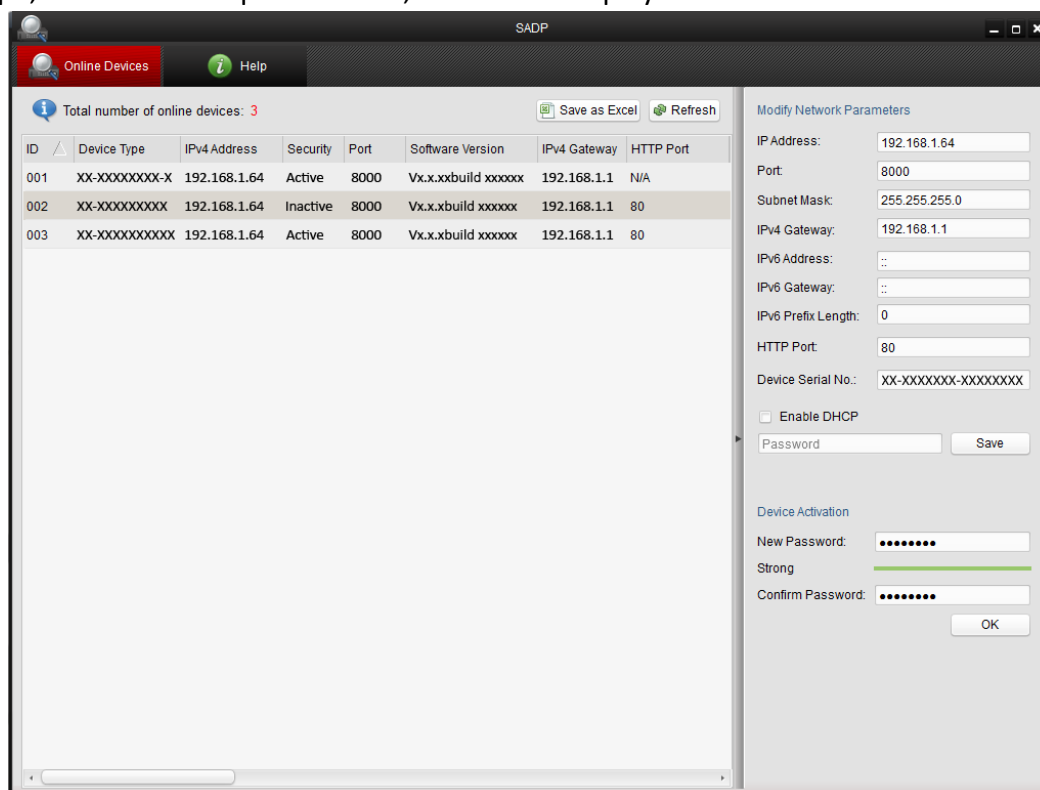
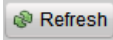

Figure A.1.1 Searching Online Devices





Note:

Device can be searched and displayed in the list in 15 seconds after it went online; it will be removed from the list in 45 seconds after it went offline.

● Search online devices manually

You can also click  Refresh to refresh the online device list manually. The newly searched devices will be added to the list.

Note:

You can click  or  on each column heading to order the information; you can click  to expand the device table and hide the network parameter panel on the right side, or click  to show the network parameter panel.

◆ Modify network parameters

Steps:

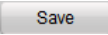
1. Select the device to be modified in the device list and the network parameters of the device will be displayed in the **Modify Network Parameters** panel on the right side.
2. Edit the modifiable network parameters, e.g. IP address and port number.
3. Enter the password of the admin account of the device in the **Password** field and click  to save the changes.



- *For your privacy and to better protect your system against security risks, we strongly recommend the use of strong passwords for all functions and network devices. The password should be something of your own choosing (Using a minimum of 8 characters, including at least three of the following categories: upper case letters, lower case letters, numbers, and special characters.) in order to increase the security of your product.*
- *Proper configuration of all passwords and other security settings is the responsibility of the installer and/or end-user.*

Modify Network Parameters

IP Address:

Port:

Subnet Mask:

IPv4 Gateway:

IPv6 Address:

IPv6 Gateway:

IPv6 Prefix Length:

Serial No.:

 Note: Enter the admin password of the device before you save the network parameters.

Figure A.1.2 Modify Network Parameters

Appendix 2 Statics, Interference Lightning and Surge Protection

This product adopts TVS plate lightning protection technology to avoid damage caused by pulse signal that is below 3000V, like instantaneous lighting stroke, surging, etc. According to the actual outdoor situation, necessary protection measures must be taken, besides ensuring the electrical safety.

- The distance between signal transmission wires and High-voltage equipment or high-voltage cable is at least 50m.
- Outdoor wiring should better be routed under eaves as much as possible.
- In the open field, wiring should be buried underground in sealed steel pipe, and the steel-pipe should be one-point grounding. Overhead routing method is forbidden.
- In strong thunderstorm area or high induction voltage areas (such as high-voltage transformer substation), high power lightning protection apparatus and lightning conductor are necessary to be added.
- The design of lightning protection and grounding of the outdoor devices and cables should be considered together with the lightning protection demand of buildings. It also must conform to the related national standards and industrial standards.
- The system should be equipotential grounded. The grounding equipment must conform to the demands of system anti-jamming and electrical safety both and it must not appear short circuit or mixed circuit with the zero conductor of strong grid. When the system is grounded alone, the resistance should be no more than 4Ω . The sectional area of the grounding cable should be no less than 25mm^2 . For grounding instructions, refer to the Installation Manual of Camera.

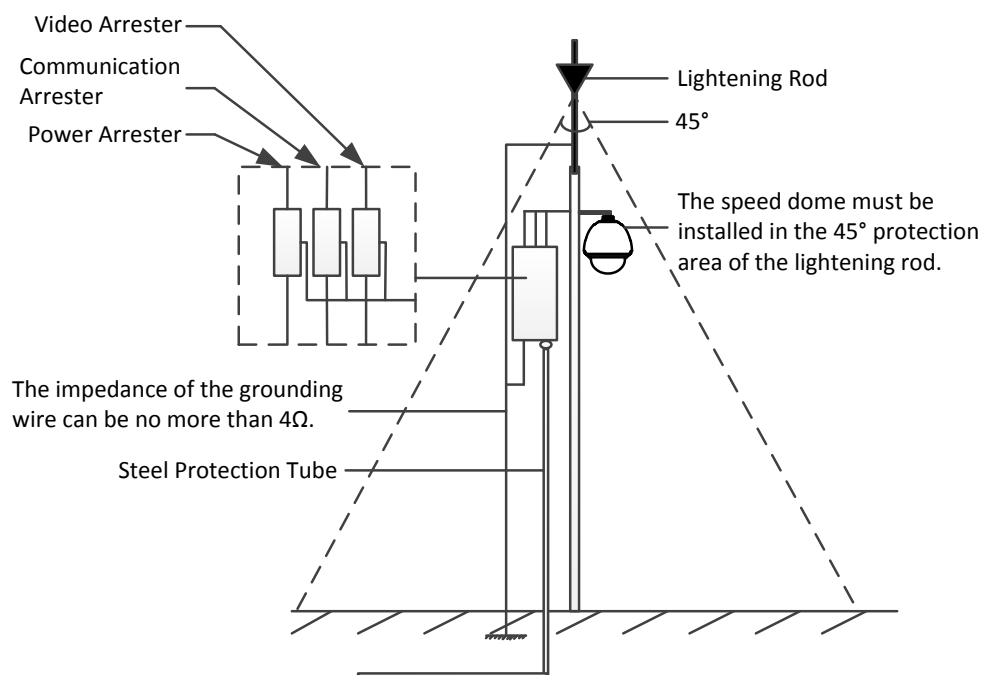

Figure A.3.1 Lightning & Surge Protection

Grounding for Cement Pole/Wall Installation:

When the camera is installed in environment where is relatively insulating to the earth, e.g., cement pole or cement wall, then only the control center requires proper grounded locally. Refer to the following figure.

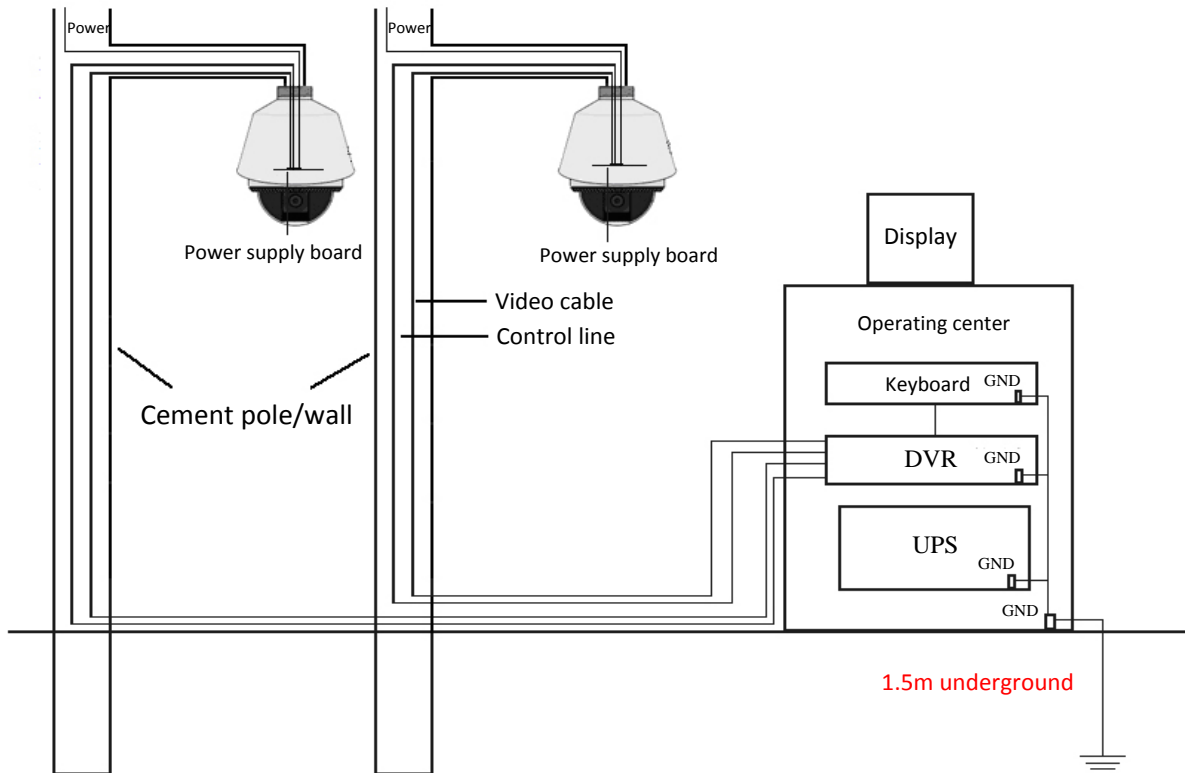

Figure A.3.2 Grounding in Cement Pole/Wall Installation

Notes:

- Because the signal transmission media of fiber optical camera and camera are isolated from the control center, they must be grounded locally to protect camera against damages.
- If the camera is installed in strong thunderstorm area, it must be grounded locally to release lightning or suchlike high energy to protect camera against damages. Refer to the following figure.

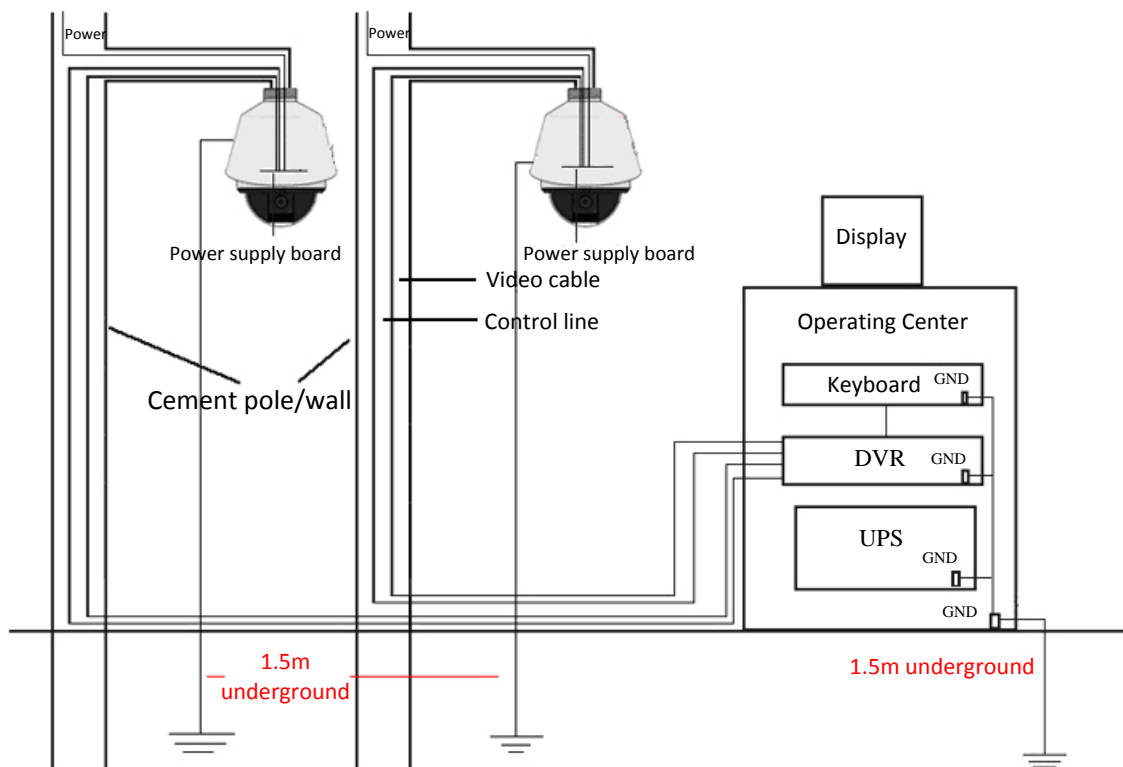

Figure A.3.3 Lightning-protection Grounding in Cement Pole/Wall Installation

Grounding for Metal Pole Installation:

When the camera is installed in environment where is conducive to the earth, e.g., metal pole, then the grounding of camera can be achieved by the properly grounded metal pole, meanwhile, the control center must be grounded locally as well. Refer to the following figure.

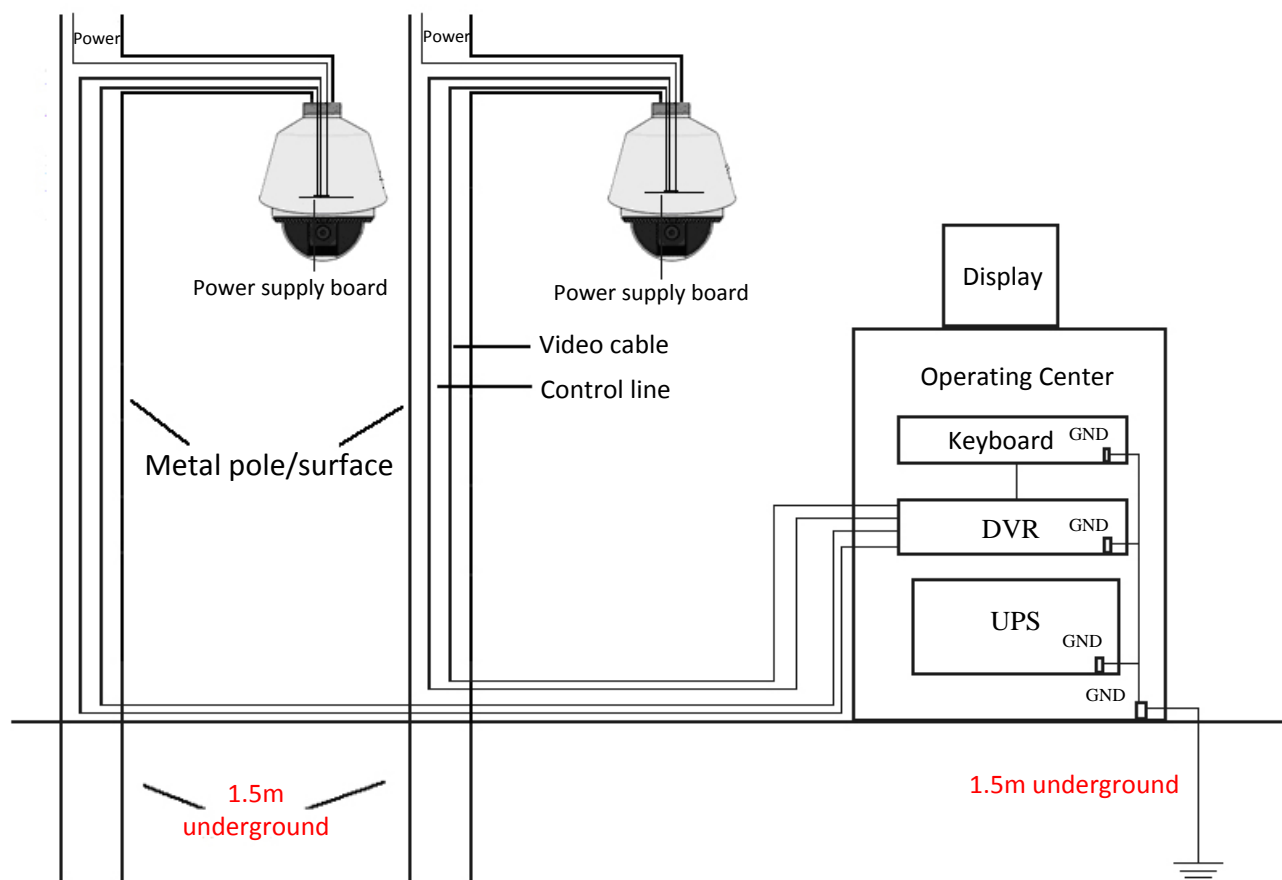

Figure A.3.4 Grounding in Metal Pole Installation

Note:

If the fiber optics, lightning protector or other device are applied during the transmission of camera, such devices as well as the video cables routing through must be proper grounded.

Appendix 3 Waterproof

Notes:

- The long-arm wall mount is recommended for the outdoor application of camera.
- You cannot use the short-arm wall mount or pendant mount for outdoor application, because it is not water-proof.
- It is recommended to use the mount with inner threaded interface and good waterproof performance.
- If you use a mount with outer threaded interface, adopt waterproof measures to the adapter applied between the mount and the camera.
- Do not install indoor camera to the outdoor environment.

L-shape Pole Mount

Make sure that the L-shape pole mount is designed with a certain inclination angle as shown in following figure. Water won't flow from the pole into the camera with the inclination angle.

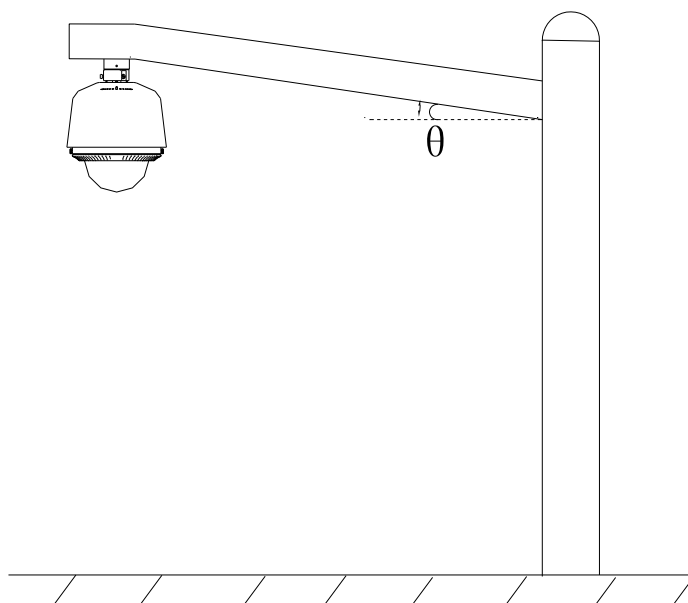

Figure A.4.1 Customized Mount

Appendix 4 Bubble Maintenance

The bubble is a transparent plastic. The dust, oil and finger print, etc. will cause scratch or image blur. Refer to the following method to clean the bubble.

- Handling dust

Use oil free soft brush or blowing dust ball to clean the dust.

- Handling oil

Steps:

1. Wipe off the water-drop or oil by soft cloth and dry the bubble.
2. Use oil free cotton cloth to wipe the bubble with alcohol or detergent.
3. Change the cloth to wipe the bubble until the bubble is clean.

Appendix 5 RS-485 Bus Connection

● General Property of RS-485 Bus

According to RS-485 industry bus standard, RS-485 is a half-duplex communication bus which has 120Ω characteristic impedance, the maximum load ability is 32 payloads (including controller device and controlled device).

● RS-485 Bus Transmission Distance

When using 0.56mm (24AWG) twisted-pair line, according to different baudrate, the maximum transmission distance theory table is shown as below:

Max. Distance of RS-485 Transmission	
Baudrate	Max Distance
2400BPS	1800m
4800BPS	1200m
9600BPS	800m

The transmission distance will be decreased if we use the thinner cable, or use this product under the strong electromagnetic interference situation, or there are lots of devices are added to the bus; on the contrary, the transmission distance will be increased.

● Connection Methods

RS-485 industry bus standard require daisy-chain connection method between any devices, both sides have to connect a 120Ω terminal resistance (show as Diagram 1), the simplified connection method is shown as diagram 2, but the distance of "D" should not be too long.

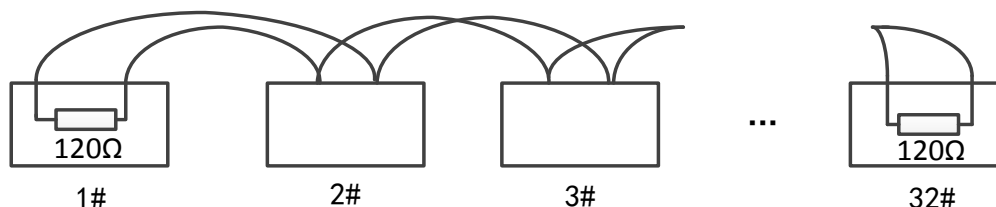

Figure A.6.1 RS-485 Connection 1

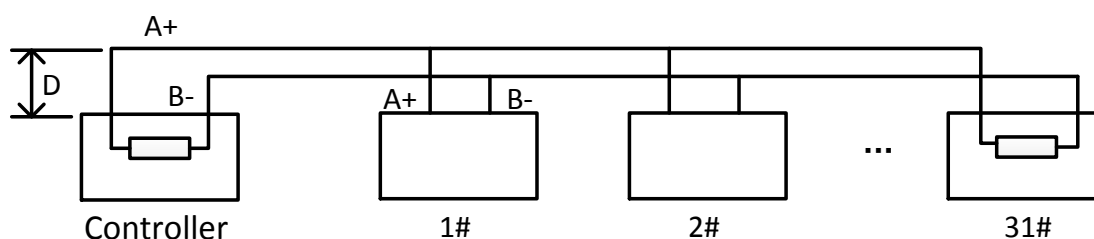

Figure A.6.2 RS-485 Connection 2

● Problems in the Practical Application

Normally, users adopt star-shape connection method in construction, under this situation, the terminal resistors must be connected between two farthest devices (as Figure A-9, 1# and 15#), but this connection method is not satisfy the requirement of the RS-485 industry standard so that it will lead to some problems such as signal reflection, anti-jamming ability decline when the devices are faraway. At this time, the camera will be uncontrollable, or self-running, etc.

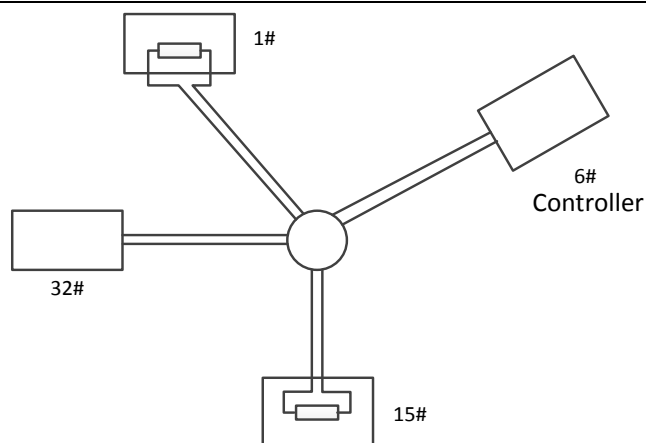

Figure A.6.3 Star Shape Connection

For such case, the best way is adding a RS-485 distributor. This product can effectively change the star-shape connection to which satisfies the requirement of RS-485 industry standard, in order to avoid those problems and improve the communication reliability. Refer to the following figure.

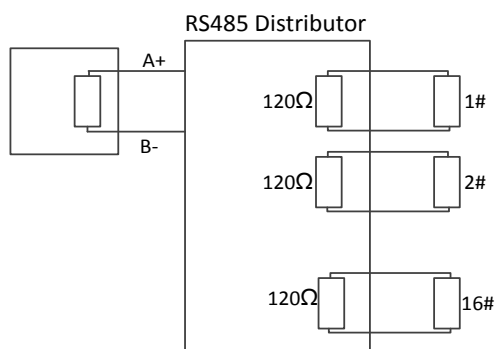

Figure A.6.4 RS-485 Distributor

- Troubleshooting of RS-485 communication

Problem	Possible Reasons	To Solve the Problem
The camera does the self-test action but cannot be controlled remotely.	1. The address or baudrate of the camera does not match with those of remote control device.	1. Adjust the address and baudrate of the remote control device to match with those of the camera.
	2. The wire RS-485+ connects to the interface RS-485- and wire RS-485- connects to the interface RS-485+.	2. Connect the wire RS-485+ to the interface RS-485+ and wire RS-485- to the interface RS-485-.
	3. The RS-485 wire is disconnected.	3. Reconnect the RS-485 wire tightly.
	4. RS-485 wire is broken.	4. Change a RS-485 wire.
The camera can be controlled but not smoothly.	1. The connection is loose.	1. Reconnect the RS-485 wire tightly.
	2. RS-485+ or RS-485-wire is broken.	2. Change a RS-485 wire.
	3. The camera is too far away from the remote control device.	3. Add a terminal resistor.
	4. Too many cameras are connected.	4. Add a RS-485 distributor.

Appendix 6 24VAC Wire Gauge & Transmission Distance

The following table describes the recommended max. distance adopted for the certain wire gauge when the loss rate of 24VAC voltage is less than 10%. For the AC driven device, the maximum voltage loss rate is 10% allowable. For example, for a device with the rating power of 80VA which is installed at a distance of 35 feet (10m) away from the transformer, then 0.8000mm is required as the minimum wire gauge.

Distance (feet) / Wire Gauge (mm) / Power (va)	0.8000	1.000	1.250	2.000
10	283(86)	451(137)	716(218)	1811(551)
20	141(42)	225(68)	358(109)	905(275)
30	94(28)	150(45)	238(72)	603(183)
40	70(21)	112(34)	179(54)	452(137)
50	56(17)	90(27)	143(43)	362(110)
60	47(14)	75(22)	119(36)	301(91)
70	40(12)	64(19)	102(31)	258(78)
80	35(10)	56(17)	89(27)	226(68)
90	31(9)	50(15)	79(24)	201(61)
100	28(8)	45(13)	71(21)	181(55)
110	25(7)	41(12)	65(19)	164(49)
120	23(7)	37(11)	59(17)	150(45)
130	21(6)	34(10)	55(16)	139(42)
140	20(6)	32(9)	51(15)	129(39)
150	18(5)	30(9)	47(14)	120(36)
160	17(5)	28(8)	44(13)	113(34)
170	16(4)	26(7)	42(12)	106(32)
180	15(4)	25(7)	39(11)	100(30)
190	14(4)	23(7)	37(11)	95(28)
200	14(4)	22(6)	35(10)	90(27)

Appendix 7 12VDC Wire Gauge & Transmission Distance

The following table describes the recommended max. distance adopted for the certain wire gauge when the loss rate of 12VDC voltage is less than 15%. For the DC driven device, the maximum voltage loss rate is 15% allowable.

Distance (feet) Power (va)	Wire Gauge (mm)			
	0.800(20)	1.000(18)	1.250 (16)	2.000(12)
10	97(28)	153(44)	234(67)	617(176)
20	49(14)	77(22)	117(33)	308(88)
24	41(12)	64(18)	98(28)	257(73)
30	32(9)	51(15)	78(22)	206(59)
40	24(7)	38(11)	59(17)	154(44)
48	20(6)	32(9)	49(14)	128(37)
50	19(6)	31(9)	47(13)	123(35)
60	16(5)	26(7)	39(11)	103(29)
70	14(4)	22(6)	33(10)	88(25)
80	12(3)	19(5)	29(8)	77(22)
90	10.8(3.1)	17(5)	26(7)	69(20)
100	9.7(2.8)	15(4)	23(7)	62(18)
110	8.9(2.5)	14(4)	21(6)	56(16)
120	8.1(2.3)	13(4)	20(6)	51(15)
130	7.5(2.1)	11.8(3.4)	18(5)	47(14)
140	7(2)	11(3.1)	17(5)	44(13)
150	6.5(1.9)	10.2(2.9)	16(4)	41(12)
160	6.1(1.7)	9.6(2.7)	15(4)	39(11)
170	5.7(1.6)	9(2.6)	14(4)	36(10)
180	5.4(1.5)	8.5(2.4)	13(4)	34(10)

Appendix 8 Table of Wire Gauge Standards

Bare Wire Gauge(mm)	American Wire Gauge AWG	British Wire Gauge SWG	Cross-sectional Area of Bare Wire(mm ²)
0.750	21		0.4417
0.800	20	21	0.5027
0.900	19	20	0.6362
1.000	18	19	0.7854
1.250	16	18	1.2266
1.500	15	17	1.7663
2.000	12	14	3.1420
2.500			4.9080
3.000			7.0683

Appendix 9 Alarm In/Out Connections

Note:

This section is only for the cameras with alarm in/out functions.

The camera can be connected with alarm inputs (0~5VDC) and alarm outputs. Refer to the following diagrams for alarm output:

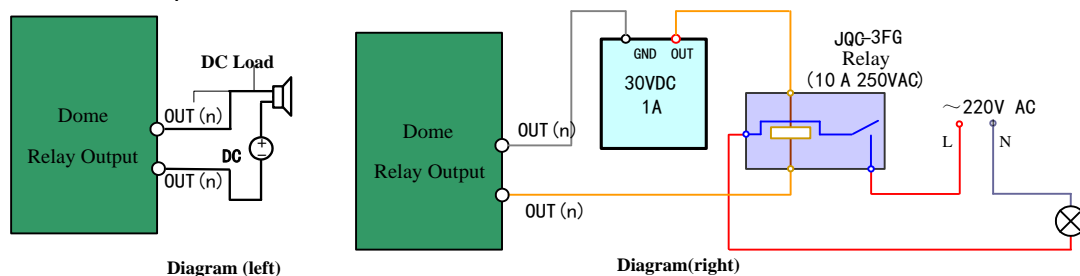

Figure A.9.1 Alarm Out Connections

The alarm provides the relay output (no voltage), and the external power supply is required when it connects to the alarm device.

- For DC power supply (left diagram), the input voltage must be no more than 30VDC, 1A.
- For AC power supply, the external relay must be used (right diagram) to prevent damages to the camera and avoid risk of electric shock.

Appendix 10 Camera Function Description

Note:

The functions vary depending on different camera models.

Limit Stops

The camera can be programmed to move within the limit stops (left/right, up/down).

Scan Modes

The camera provides 5 scan modes: auto scan, tilt scan, frame scan, random scan and panorama scan.

Preset Freezing

This feature freezes the scene on the monitor when the camera is moving to a preset. This allows for smooth transition from one preset scene to another. It also guarantees that masked area will not be revealed when the camera is moving to a preset.

Presets

A preset is a predefined image position. When the preset is called, the camera will automatically move to the defined position. The presets can be added, modified, deleted and called.

Label Display

The on-screen label of the preset title, azimuth/elevation, zoom, time and camera name can be displayed on the monitor. The displays of time and camera name can be programmed.

Auto Flips

In manual tracking mode, when a target object goes directly beneath the camera, the video will automatically flips 180 degrees in horizontal direction to maintain continuity of tracking. This function can also be realized by auto mirror image depending on the models of camera.

Privacy Mask

This function allows you to block or mask certain area of a scene, for preventing the personal privacy from recording or live viewing. A masked area will move with pan and tilt functions and automatically adjust in size as the lens zooms telephoto and wide.

3D Positioning

In the client software, use the left key of mouse to click on the desired position in the video image and drag a rectangle area in the lower right direction, then the camera system will move the position to the center and allow the rectangle area to zoom in. Use the left key of mouse to drag a rectangle area in the upper left direction to move the position to the center and allow the rectangle area to zoom out.

Proportional Pan/Tilt

Proportional pan/tilt automatically reduces or increases the pan and tilt speeds according to the amount of zoom. At telephoto zoom settings, the pan and tilt speeds will be slower than at wide zoom settings. This keeps the image from moving too fast on the live view image when there is a large amount of zoom.

Auto Focus

The auto focus enables the camera to focus automatically to maintain clear video images.

Day/Night Auto Switch

The cameras deliver color images during the day. And as light diminishes at night, the cameras switch to night mode and deliver black and white images with high quality.

Slow Shutter

In slow shutter mode, the shutter speed will automatically slow down in low illumination conditions to maintain clear video images by extending the exposure time. The feature can be enabled or disabled.

Backlight Compensation (BLC)

If you focus on an object against strong backlight, the object will be too dark to be seen clearly. The BLC

(Backlight Compensation) function can compensate light to the object in the front to make it clear, but this causes the over-exposure of the background where the light is strong.

Wide Dynamic Range (WDR)

The wide dynamic range (WDR) function helps the camera provide clear images even under back light circumstances. When there are both very bright and very dark areas simultaneously in the field of view, WDR balances the brightness level of the whole image and provide clear images with details.

White Balance (WB)

White balance can remove the unrealistic color casts. White balance is the white rendition function of the camera to adjust the color temperature according to the environment automatically.

Patrol

A patrol is a memorized series of pre-defined preset function. The scanning speed between two presets and the dwell time at the preset are programmable.

Pattern

A pattern is a memorized series of pan, tilt, zoom, and preset functions. By default the focus and iris are in auto status during the pattern is being memorized.

Power Off Memory

The camera supports the power off memory capability with the predefined resume time. It allows the camera to resume its previous position after power is restored.

Time Task

A time task is a preconfigured action that can be performed automatically at a specific date and time. The programmable actions include: auto scan, random scan, patrol 1-8 ,pattern 1-4, preset 1-8,frame scan, panorama scan, tilt scan, day, night, reboot, PT adjust, Aux Output, etc.

Park Action

This feature allows the camera to start a predefined action automatically after a period of inactivity.

User Management

The camera allows you to edit users with different levels of permission, in the admin login status. Multiple users are allowed to access and control the same camera via network simultaneously.

3D Digital Noise Reduction

Comparing with the general 2D digital noise reduction, the 3D digital noise reduction function processes the noise between two frames besides processing the noise in one frame. The noise will be much less and the video will be clearer.

Dual-VCA

Combine the detected VCA information into the video stream, which can be used for the second-time analysis on the back-end device.



First Choice for Security Professionals